

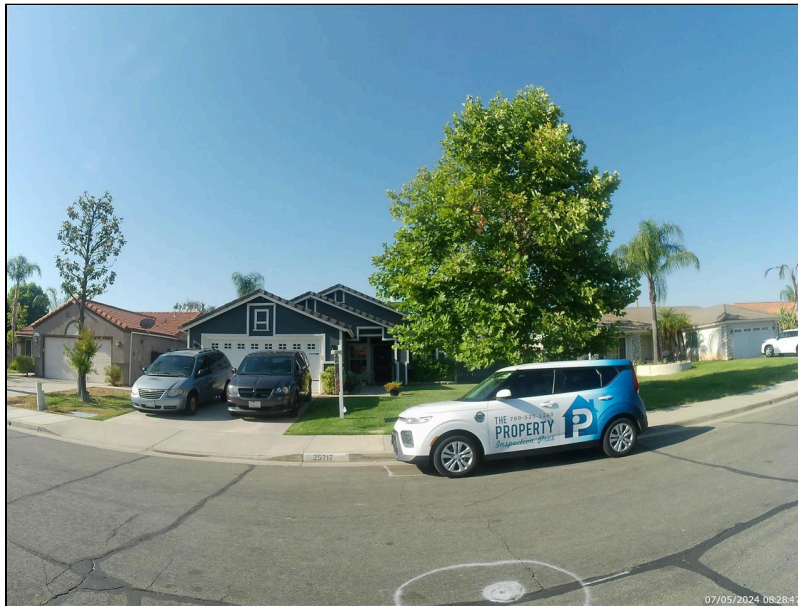

Inspection Report

Jimmy Smith

Property Address:
1241 Main Ct
Menifee CA 92584



The Property Inspection Pros

Jeff Duncan
www.tpips.com
jduncan@tpips.com
Cell - 760-525-5340
Certified Master Inspector



Table of Contents

Cover Page..... 1
Table of Contents 3
Intro Page 4
1 Roofing 8
2 Exterior 12
3 Electrical System 17
4 Garage 25
5 Water Heater 31
6 Interiors 34
7 Plumbing System 40
8(A) Bathroom(s) / Hall Bathroom..... 43
8(B) Bathroom(s) / Master Bathroom 44
9 Laundry..... 46
10 Fireplaces/ Chimneys 47
11 Detectors, Safety, Security 48
12 Heating Equipment 49
13 Cooling Equipment..... 53
14 Ventilation and Insulation 56
15 Structural Components 58
16 Built-In Kitchen Appliances 60
17 Gas, Electric, Water Shut-Off Locations 64
18 POOL, SPA, EQUIPMENT & SAFETY 66
General Summary 75

Date: 7/5/2024	Time: 09:00 AM	Report ID:
Property: 1241 Main Ct Menifee CA 92584	Customer: Jimmy Smith	Real Estate Professional:

IN ATTENDANCE DURNING THE INSPECTION: BUYER, BUYER'S AGENT, INSPECTOR, SELLER(S)	TYPE OF BUILDING: SINGLE FAMILY DETACHED, WITH POOL/ SPA	APPROXIMATE YEAR BUILT (BASED ON BUYERS AGENT-BUYER-OR/MLS): 1992
WEATHER TYPE: CLEAR	TEMPERATURE: 90, DEGREES	GROUND/ SOIL SURFACE CONDITIONS: DRY
RAINED IN THE LAST 3 DAYS: NO	NUMBER OF LEVELS: 1	UTILITIES: ALL UTILITIES WERE ON
OCCUPIED: YES	POOL/ SPA INSPECTION: YES	

PLEASE READ THE FOLLOWING INFORMATION

The purpose of this inspection is to assess the general condition of the property. Our Inspectors are Generalists and not Specialists. Further evaluated by licensed contractors who through their evaluations may identify additional material defects or adverse conditions that could result in injury or lead to costs that would significantly affect your evaluation of the property. We highly recommend that you follow our further evaluation recommendations as outlined in your inspection report prior to the end of your contingency period. Special attention is given to identifying deficiencies in systems and components that require immediate repair, or that need further investigation. Chips, cracks, blemishes, etc. that are cosmetic in nature are not reportable items. The Client(s) is/are therefore advised to inspect and evaluate such items personally and take corrective action(s) if concerned.

This report is the exclusive property of The Property Inspection Pros and the client(s) whose name appears herewith, and its use by any unauthorized persons is strictly prohibited. The observations and opinions expressed within this report are those of The Property Inspection Pros and supersede any alleged verbal comments. We inspect all of the systems, components, and conditions described in accordance with the International Association of Certified Home Inspectors Standards of Practice of a General Home Inspection.

SCOPE OF THE INSPECTION:

The Property Inspection Pros Inspectors will inspect all properties in accordance with the International Association of Certified Home Inspectors, Standards of Practice of a General Home Inspection. We respectfully ask that you read and become familiar with these Standards of Practice at the following link: **STANDARDS OF PRACTICE** If you have any questions or concerns of these Standard of Practice of a General Home Inspection please contact us 760-525-6154.

The Property Inspection Pros provides you with a basic overview of the condition of the property at the time

and date of the inspection. The purpose of your Home Inspection is to evaluate the general condition of the structure at the noted address. This includes determining whether systems are still performing their intended functions. The inspection to be performed for Client(s) is a limited, visual, non-invasive, non-destructive, nontechnically exhaustive evaluation, performed for a determined fee, designed to identify material defects in the systems, structures, and components of the above-referenced primary building and its associated primary parking structure as they exist at the time and date of the inspection. A material defect is a condition that significantly affects the value, desirability, habitability or safety of the building. Style or aesthetics shall not be considered in determining whether a specific system, structure, or component is defective. The inspection shall be limited to those specific systems, structures, and components that are present and visually accessible at the date and time of the inspection. Components and systems shall be operated with normal user controls only and as conditions and limitations permit. The inspection provides a general overview of the more obvious repairs or replacement that may be needed. It is not intended to be an exhaustive list. The ultimate decision of what to repair or replace is yours. One homeowner may decide that certain conditions require repair or replacement, while another will not. There are limitations to the scope of this Inspection.

The inspection report shall describe and identify the inspected systems, structures, and components of the building and identify material defects in those systems, structures, and components observable during the inspection, with limitations. Defects that are concealed/ are not accessible are specifically disclaimed. This includes defects that are concealed in/ behind the walls and wall coverings, in/ behind the floors and floor coverings, concealed by fresh paint, soil, vegetation, or other landscaping, or by stored items throughout the interior or exterior of the house/ property. Client(s) understands that the inspector shall use specialized tools at aid in the inspection process with the Client(s) best interest in mind, but that some concealed defects may go undetected and are unable to be reported on. Inspectors will not find conditions that may only be visible when storage or furniture is moved. Inspectors do not remove wallpaper, look behind pictures, and move furniture / stored items, lift flooring (including carpet) to look underneath, or cut / remove vegetation / landscaping. Client(s) agrees to hold the Inspector and The Property Inspection Pros harmless if Client(s) or any of the Client(s) representatives discovers concealed defects that were undetected at the time and date of the inspection.

LIMITATIONS, EXCEPTIONS AND EXCLUSIONS:

Excluded from this limited, visual, non-intrusive, non-destructive, non-technically exhaustive generalist inspection of the structure is any system, structure, or component of the building which is inaccessible, concealed from view, or cannot be inspected due to circumstances beyond the control of Inspector, or which Client(s) has agreed is not to be inspected. In addition to concealed defects, the following are excluded from the scope of this inspection unless specifically agreed to in writing:

1. Determining compliance with each manufacturers' specifications, researching building codes for the year built or modified, ordinances, regulations, covenants, or other restrictions (such as HOA rules), including local interpretations thereof.
2. Obtaining or reviewing information from any third-parties including, but not limited to: government agencies (such as permits), component or system manufacturers (including product defects, recalls or similar notices, unless agreed to in writing), square footage, contractors, managers, sellers, occupants, neighbors, consultants, homeowner or similar associations, attorneys, agents or brokers. The Property Inspection Pros does not endorse nor inspect unpermitted structures or additions and exclusively disclaims them from our inspection and inspection report. Geotechnical, engineering, structural, architectural, geological, hydrological, land surveying or soils-related examinations.
3. Examination of conditions related to animals, rodents, insects, wood-destroying insects, organisms, mold, and mildew or the damage caused thereby. Mold determination is not part of this inspection (unless agreed to in writing). If evidence of unidentified stains is noted, a specialist should be consulted to determine type. Mold has been known to cause health risks. The Inspector does not look for, or comment on, the past use of chemical termite treatments in or around the property.
4. Certain factors relating to any systems, structures, or components of the building, including, but not limited to: Recalls, adequacy, efficiency, durability or remaining useful life, costs to repair, replace or operate, fair market value, marketability, quality, or advisability of purchase.
5. Environmental hazards or conditions, including, but not limited to, toxic, reactive, combustible, corrosive contaminants, wildfire, geologic or flood.
6. Dismantling of any system, structure, or component, or perform any intrusive or destructive examination, test or analysis. Inspector is limited to evaluating components from standard service or access covers.
7. Examining or evaluating fire-resistive qualities of any system, structure or component of the building.
8. Systems, structures, or components of the building, which are not permanently installed (such

as refrigerators, washing machines and dryers, window AC, etc). 9. Systems, structures, or components that are not part of the main house, unless specifically identified in the written inspection report. 10. Common areas, or systems, structures, or components thereof, including, but not limited to, those of a common interest (HOA). 11. Examining or evaluating the acoustical or other nuisance characteristics of any system, structure, or component of a building, complex, adjoining properties, or neighborhood. 12. Operating or evaluating low voltage electrical, antennas, security systems, cable or satellite television, telephone, remote controls, radio controls, timers, intercoms, computers, computer networks, photo-electric, motion sensing, or other such similar non-primary electrical power devices, exterior yard lighting, components, or systems. 13. Evaluation of any pool/spa, barn, fence, irrigation system, built in BBQs or other structures unless agreed to in writing. 14. Evaluation of any type of electric Solar system and related components on or off the house/ structure. 15. Examining or operating any sewage disposal system or component including, but not limited to: septic tanks and/or any underground system or portion thereof, or ejector pumps for rain or waste. 16. Environmental evaluation and inspection. The building inspection is not intended to determine the presence of lead, radon, mold, Polychlorinated biphenyls (PCB's), mildew, urea- formaldehyde, asbestos, sulfur, contaminated drywall, Chinese drywall, or other toxins in the building, ground, water or air. 17. It is beyond the scope of this inspection to determine if any system or component is, has been, or will be part of any product, component or system recall. We highly recommend Client(s) subscribe or contact the CPSC (Consumer Product Safety Commission) for recall information regarding any system or component if concerned.

A home inspection is not a pest inspection. Any observations which the inspector may make in this report regarding evidence of peats or wood destroying organisms, are not a substitute for an inspection by a qualified licensed pest control operator or exterminator. Your inspector may only report on a portion of the currently visible conditions and cannot render an opinion regarding their cause, condition, or remediation. We recommend a careful review of any recent pest control inspection report concerning pest activity or wood destroying organisms on this property. If no such report is available, we recommend that a pest control inspection be performed on the property prior to the end of your contingency period.

Thank you for choosing The Property Inspection Pros for your property inspection needs. We hope the information contained in your report is beneficial to you. If there are areas that you have questions about or would like further explanation, please don't hesitate to call us. Your satisfaction is important to us.

Comment Key or Definitions

The following definitions of comment descriptions represent this inspection report. All comments by the inspector should be considered before purchasing this home. Any recommendations by the inspector to repair or replace suggests a second opinion or further inspection by a qualified contractor. All costs associated with further inspection fees and repair or replacement of item, component or unit should be considered before you purchase the property.

Inspected (IN) = I visually observed the item, component or unit and if no other comments were made then it appeared to be functioning as intended allowing for normal wear and tear.

Not Inspected (NI)= I did not inspect this item, component or unit and made no representations of whether or not it was functioning as intended and will state a reason for not inspecting.

Not Present (NP) = This item, component or unit is not in this home or building.

Repair or Replace (RR) = The item, component or unit is not functioning as intended, or needs further

inspection by a qualified contractor. Items, components or units that can be repaired to satisfactory condition may not need replacement.

Information Only (IO) = This item, is for your information only.

Please accept this one year FREE membership to HOCOA your home repair network on my behalf. It's easy to get started just go to this link [HOCOA](#) and fill out the short form. You will then receive your FREE membership kit in the mail in a few days.

THE TERMS 'FRONT,' 'REAR,' 'LEFT,' AND 'RIGHT' ARE USED IN REFERENCE TO THE PROPERTY AS VIEWED FROM THE FRONT ENTRY DOOR.

Inspected in accordance with "THE INTERNATIONAL ASSOCIATION OF CERTIFIED HOME INSPECTORS STANDARDS OF PRATICE AND CODE OF ETHICS".

This home is older and the home inspector considers this while inspecting. It is common to have areas that no longer comply with current code. This is not a new home and this home cannot be expected to meet current code standards. While this inspection makes every effort to point out safety issues, it does not inspect for code. It is common that homes of any age will have had repairs performed and some repairs may not be in a workmanlike manner. Some areas may appear less than standard. This inspection looks for items that are not functioning as intended. It does not grade the repair. It is common to see old plumbing or mixed materials. Sometimes water signs in crawlspaces or basements could be years old from a problem that no longer exists. Or, it may still need further attention and repair. Determining this can be difficult on an older home. Sometimes in older homes there are signs of damage to wood from wood eating insects. Having this is typical and fairly common. If the home inspection reveals signs of damage you should have a pest control company inspect further for activity and possible hidden damage. The home inspection does not look for possible manufacturer re-calls on components that could be in this home. Always consider hiring the appropriate expert for any repairs or further inspection.

1. Roofing

The home inspector shall observe: Roof covering; Roof drainage systems; Flashings; Skylights, chimneys, and roof penetrations; and Signs of leaks or abnormal condensation on building components. The home inspector shall: Describe the type of roof covering materials; and Report the methods used to observe the roofing. The home inspector is not required to: Walk on the roofing; or Observe attached accessories including but not limited to solar systems, antennae, and lightning arrestors. We do not verify that the materials are installed according to manufacturer's specifications. We recommend that all stains be further evaluated by a qualified licensed roof contractor prior to the end of your contingency period and repaired as necessary.



Note: We recommend that all roofs be inspected and maintained periodically by a qualified licensed roof contractor.

IN= Inspected, NI= Not Inspected, NP= Not Present, RR= Repair or Replace, IO= Information Only

IN NI NP RR IO Items

1.0 ROOF COVERING (SURFACE OF ROOFING MATERIAL)
ROOF COVERING: AGED/ WORN, 3-TAB FIBERGLASS

1.1 TILE ROOF MATERIALS

Comments:
 (1) **Photo(s) of the roof.**



1.1 Item 1(Picture)

IN NI NP RR IO Items

IN= Inspected, NI= Not Inspected, NP= Not Present, RR= Repair or Replace, IO= Information Only



1.1 Item 2(Picture)

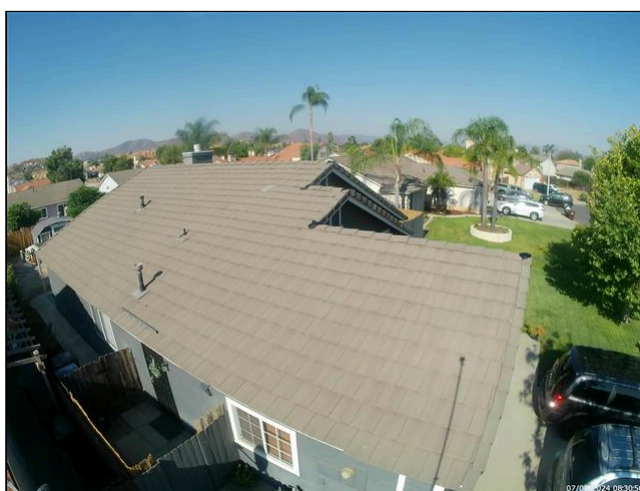

1.1 Item 3(Picture)



1.1 Item 4(Picture)

(2) The roof covering was inspected from the ground, windows, attic and remotely with the use of a pole-mounted camera to avoid damaging the roof covering and possibly voiding any manufacture warranties and safety for the inspector. This is not a

IN NI NP RR IO Items

comprehensive inspection of the roof and is in accordance with the InterNACHI standards of practice we follow. All of the flashings and/pipe penetrations were not fully visible from our vantage point. I cannot guarantee that all of the pipe penetrations and flashings are in good condition. If you want a more comprehensive roof inspection, we recommend that you have the roof inspected by a licensed roof contractor prior to the end of your contingency. Be advised that a licensed roof contractor with the added benefit of walking the roof may find additional defects not listed in this report.

1.2 FLASHINGS AND ROOF PENETRATIONS

Comments:

Drip edge flashing was not installed at the roof. Lack of roof drip edge flashing leaves the edges/eaves of roof sheathing, fascia and underlayment exposed to potential moisture damage from wood decay and/or delamination. We recommend having drip edge flashing installed by a licensed roof contractor.



1.2 Item 1(Picture)

1.3 ROOF DRAINAGE (GUTTERS/ DOWNSPOUTS)

Comments:

IN NI NP RR IO Items

IN= Inspected, NI= Not Inspected, NP= Not Present, RR= Repair or Replace, IO= Information Only

IN NI NP RR IO Items

Gutters, downspouts and drain lines are not installed. We recommend installing gutters and downspouts to prevent erosion or water intrusion around the house by diverting run off away from the house by a qualified licensed contractor.



1.3 Item 1(Picture)

1.4 ROOF SHEATHING (OBSERVABLE)

IN NI NP RR IO Items

IN= Inspected, NI= Not Inspected, NP= Not Present, RR= Repair or Replace, IO= Information Only

The roof of the home was inspected and reported on with the above information. While the inspector makes every effort to find all areas of concern, some areas can go unnoticed. Roof coverings and skylights can appear to be leak proof during inspection and weather conditions. Our inspection makes an attempt to find a leak but sometimes cannot. Please be aware that the inspector has your best interest in mind. However, we do not predict the remaining life, the integrity, or guarantee that the roof will not leak. We also recommend obtaining a home warranty that includes coverage for the roof (s). Any repair items mentioned in this report should be considered before purchase. It is recommended that qualified licensed contractors be used in your further inspection or repair issues as it relates to the comments in this inspection report.

Note: This roof inspection reports on the type and condition of the roofing materials, missing and/or damaged materials, and attachments (excluding solar systems, antennas, etc.) where visible. This does not constitute a warranty, guarantee, roof certification, or life expectancy evaluation of any kind. Roofs are not water tested for leaks. The condition of the roofing underlayment material was not verified/inspected. For further evaluation and a roof certification, we recommend you consult a qualified licensed roofing contractor prior to the end of your contingency period.

2. Exterior

The home inspector shall observe: Wall cladding, flashings, and trim; Entryway doors and a representative number of windows; Garage door operators; Decks, balconies, stoops, steps, areaways, porches and applicable railings; Eaves, soffits, and fascias; and Vegetation, grading, drainage, driveways, patios, walkways, and retaining walls with respect to their effect on the condition of the building. The home inspector shall: Describe wall cladding materials; Operate all entryway doors and a representative number of windows; Operate garage doors manually or by using permanently installed controls for any garage door operator; Report whether or not any garage door operator will automatically reverse or stop when meeting reasonable resistance during closing; and Probe exterior wood components where deterioration is suspected. The home inspector is not required to observe: Storm windows, storm doors, screening, shutters, awnings, and similar seasonal accessories; Fences; Presence of safety glazing in doors and windows; Garage door operator remote control transmitters; Geological conditions; Soil conditions; Recreational facilities (including spas, saunas, steam baths, swimming pools, tennis courts, playground equipment, and other exercise, entertainment, or athletic facilities); Detached buildings or structures; or Presence or condition of buried fuel storage tanks. The home inspector is not required to: Move personal items, panels, furniture, equipment, plant life, soil, snow, ice or debris that obstructs access or visibility.



Property Notes: Identifying the location of property lines, easements, and other property restrictions, and their implications to existing structures are beyond the scope of our general home inspection.

IN= Inspected, NI= Not Inspected, NP= Not Present, RR= Repair or Replace, IO= Information Only

IN NI NP RR IO Items

2.0 EXTERIOR (GENERAL COMMENTS)

Comments:

Unsecured items in a yard may be hazardous. Inspecting unsecured items for proper installation is beyond the scope of our general home inspection. We recommend that any unsecured items be checked by you or by a qualified person to ensure proper installation.

2.1 VEGETATION (WITH RESPECT TO ITS EFFECT ON THE BUILDING)

2.2 GRADING AND DRAINAGE (WITH RESPECT TO ITS EFFECT ON THE BUILDING)

LOT TYPE: FLAT

LOT DRAINAGE: GRADED, BURRIED DRAIN LINES

Comments:

Ground drain lines were visible in the yard at several areas. These drains are not tested for functional flow or adequacy. It is important to maintain these drains and prevent debris from entering. We recommend having all ground drain lines inspected and cleaned after moving into the property and on a periodic basis by a qualified person.

2.3 WALL CLADDING FLASHING AND TRIM

SIDING MATERIAL: WOOD, WOOD TRIM

Comments:

Several gaps were observed at the siding. These gaps can allow water to flow behind the siding causing damage. We recommend caulking the gaps as needed to seal the siding and prevent water intrusion.

2.4 EAVES, SOFFITS, FASCIAS

2.5 DOORS (EXTERIOR)

Comments:

Paint is worn and failing at the wood doors at several areas. We recommend prep and

IN NI NP RR IO Items

IN= Inspected, NI= Not Inspected, NP= Not Present, RR= Repair or Replace, IO= Information Only

IN NI NP RR IO Items

paint as needed to protect the siding and trim by a qualified paint contractor.



2.5 Item 1(Picture)



2.6 WINDOWS (INTERIOR AND EXTERIOR)

WINDOWS: DOUBLE PANE ALUMINUM

Comments:

(1) There are several window screens that are damaged throughout the house. We recommend repair or replace as needed by a qualified person.

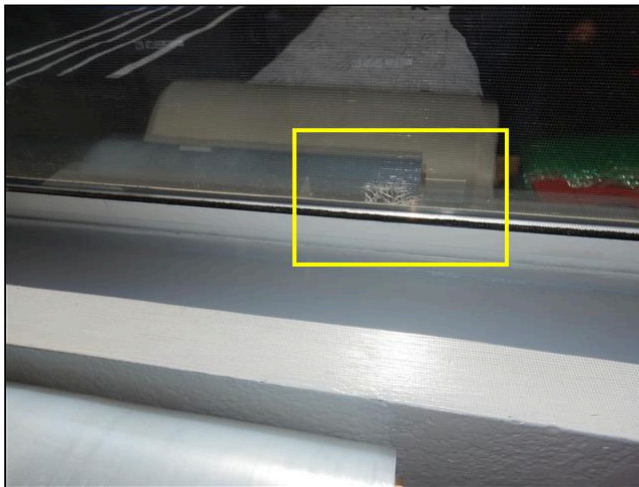

2.6 Item 1(Picture)

(2) Dual Pane Window Note - Failed seals in insulated glass dual pane windows are not always visible or detectable. In some instances the home inspector may not be able to disclose the exact condition of every window, depending on the ambient conditions or if the windows are dirty at the time of the inspection. Windows are reported as they are observed at the time of the inspection only. If you have present or future concerns regarding the integrity of the dual pane thermal seals, we strongly recommend that you consult with a qualified licensed window contractor for further evaluation. This inspection is not a guarantee of any kind regarding the integrity of the dual pane windows.



2.7 SAFETY GLASS (EXTERIOR)

IN NI NP RR IO Items

IN= Inspected, NI= Not Inspected, NP= Not Present, RR= Repair or Replace, IO= Information Only

IN NI NP RR IO Items

2.8 DRIVEWAYS, PATIOS, WALKWAYS (HARDSCAPE)

DRIVEWAY: CONCRETE

Comments:

(1) There is a crack in the concrete driveway. We recommend necessary repairs by a licensed concrete contractor.



2.8 Item 1(Picture)

(2) There are several cracks in the concrete patio. We recommend necessary repairs by a licensed concrete contractor.



2.8 Item 2(Picture)

2.9 EXTERIOR STAIRS/ STEPS

2.10 FENCE AND/OR GATES

Comments:

(1) The fence and gates are loose, leaning and deteriorated in several areas. We recommend necessary repairs or replacing as needed by a licensed fence contractor.

(2) The left side gate is damaged. We recommend necessary repairs or replacing as needed by a licensed fence contractor.

(3) There is a lock installed on the right side gate. This gate could not be inspected for proper operation due to this condition. We recommend having the lock removed and

IN NI NP RR IO Items

IN= Inspected, NI= Not Inspected, NP= Not Present, RR= Repair or Replace, IO= Information Only

IN NI NP RR IO Items

verifying that the gate is operational by a qualified person prior to the end of your contingency period.

(4) Vegetation is growing on the fence in several areas. Vegetation can hold moisture to the fence and cause excessive weight and damage. We recommend trimming back and removing the vegetation by a qualified licensed landscaper.



2.10 Item 1(Picture)

2.11 OUTLETS/ WIRING/ FIXTURES

2.12 IRRIGATION

Comments:

Landscape sprinklers or irrigation systems are beyond the scope of our general home inspection. We did not inspect or check any type of landscape sprinklers or irrigation systems. We recommend verifying that the landscape sprinklers or irrigation systems are functional by a qualified person prior to the end of your contingency period.

2.13 ADDITIONAL BUILDINGS/ STRUCTURES ON THE PROPERTY

Comments:

We did not inspect any additional buildings or structures on the property. I only inspected the main structure on the property. Deficiencies may exist with these structures or building (s). Our company makes no representation to the condition of these structures or building (s). We do recommend that any and all additional buildings on the property be inspected prior to the end of your contingency period.

2.14 EXTERIOR - OTHER

Comments:

Note: 1) The soil grade should be maintained at least 4 inches below the top of the foundation and not in contact with wood products. This helps to prevent moisture damage and termite infestation. 2) The condition and/ or presence of flashing, including window and door flashing, is hidden behind the exterior siding and cannot be viewed. The inspector relies on signs of leakage at the interior to determine the fitness of this component. 3) Minor cracks in stucco finishes are to be expected and will normally not effect the integrity of stucco siding or the waterproofing system. 4) Exterior wood members are prone to damage. Regular maintenance, including painting is needed often to prevent damage. All gaps in the siding and trim should be sealed or otherwise maintained to prevent water intrusion. 5) We do not identify wood damaged by

IN NI NP RR IO Items

IN= Inspected, NI= Not Inspected, NP= Not Present, RR= Repair or Replace, IO= Information Only

IN NI NP RR IO Items

moisture and pests. Inspection by a qualified licensed pest inspection company is needed to report on such damage and is strongly recommended.

IN NI NP RR IO Items

IN= Inspected, NI= Not Inspected, NP= Not Present, RR= Repair or Replace, IO= Information Only

The exterior of the home was inspected and reported on with the above information. While the inspector makes every effort to find all areas of concern, some areas can go unnoticed. Please be aware that the inspector has your best interest in mind. Any repair items mentioned in this report should be considered before purchase. It is recommended that qualified licensed contractors be used in your further inspection or repair issues as it relates to the comments in this inspection report.

3. Electrical System

The home inspector shall observe: Service entrance conductors; Service equipment, grounding equipment, main over current device, and main and distribution panels; Amperage and voltage ratings of the service; Branch circuit conductors, their over current devices, and the compatibility of their ampacities and voltages; The operation of a representative number of installed ceiling fans, lighting fixtures, switches and receptacles located inside the house, garage, and on the dwelling's exterior walls; The polarity and grounding of all receptacles within six feet of interior plumbing fixtures, and all receptacles in the garage or carport, and on the exterior of inspected structures; The operation of ground fault circuit interrupters; and Smoke detectors. The home inspector shall describe: Service amperage and voltage; Service entry conductor materials; Service type as being overhead or underground; and Location of main and distribution panels. The home inspector shall report any observed aluminum branch circuit wiring. The home inspector shall report on presence or absence of smoke detectors, and operate their test function, if accessible, except when detectors are part of a central system. The home inspector is not required to: Insert any tool, probe, or testing device inside the panels; Test or operate any over current device except ground fault circuit interrupters; Dismantle any electrical device or control other than to remove the covers of the main and auxiliary distribution panels; or Observe: Low voltage systems; Security system devices, heat detectors, or carbon monoxide detectors; Telephone, security, cable TV, intercoms, or other ancillary wiring that is not a part of the primary electrical distribution system; or Built-in vacuum equipment.



IN= Inspected, NI= Not Inspected, NP= Not Present, RR= Repair or Replace, IO= Information Only

IN NI NP RR IO Items

3.0 MAIN PANEL

MAIN PANEL CAPACITY: 100 AMP
ELECTRIC SERVICE CONDUCTORS: BELOW GROUND, 220 VOLTS

Comments:
Photo of the main electrical panel.



3.0 Item 1(Picture)

3.1 SUB PANEL

3.2 CIRCUIT BREAKERS/ FUSES

PANEL TYPE: CIRCUIT BREAKERS

Comments:
 (1) **Photo inside of the main electrical panel.**

The dead front cover was removed at the time of the inspection and the breakers, wiring

IN NI NP RR IO Items

IN= Inspected, NI= Not Inspected, NP= Not Present, RR= Repair or Replace, IO= Information Only

and grounding were inspected. Appears to be functioning as intended.



3.2 Item 1(Picture)



3.2 Item 2(Picture)

(2) Breakers were observed in the main panel which are from a manufacturer that is different than the panel manufacture. Most panel manufacturers require like-kind breakers to be installed from the same manufacture. Having breakers from another manufacturer could void the UL listing. We recommend further evaluation by a qualified licensed electrician and necessary corrections as needed.



3.3 BRANCH CIRCUIT CONDUCTORS/ WIRING

BRANCH WIRE 15 AND 20 AMP: COPPER
WIRING METHODS: ROMEX

Comments:

- (1) Home inspectors do not evaluate individual circuits for capacities, or identify which receptacles are on a particular circuit, or verify the labeling of the breakers. If concerned about the capacity of individual circuits for their capacities and the correct labeling of the breakers we recommend further evaluation by a qualified licensed electrician prior to the end of your contingency period for verification of these items.
- (2) Wires for some lighting fixtures in the attic space were observed to be unsecured.

IN NI NP RR IO Items

We recommend necessary corrections by a qualified licensed electrician.



3.3 Item 1(Picture)



3.3 Item 2(Picture)

IN NI NP RR IO Items

IN= Inspected, NI= Not Inspected, NP= Not Present, RR= Repair or Replace, IO= Information Only

IN NI NP RR IO Items

(3) Unprotected Romex was present in the attic adjacent to the attic scuttle. Romex located within 6 feet of the attic scuttle must be protected from damage. We recommend adding protection to the Romex in attic by the access a qualified licensed electrician.



3.3 Item 3(Picture)

3.4 SERVICE AND GROUNDING EQUIPMENT

Comments:

The electrical system appears to be grounded through the plumbing system only which was standard at the time of construction. Newer homes have a separate ground rod which improves grounding. We recommend having a ground rod and wire installed by a qualified licensed electrician to improve grounding and safety.

3.5 CONNECTED DEVICES AND FIXTURES (REPRESENTATIVE NUMBER)

3.6 SWITCHES

3.7 POLARITY AND GROUNDING (OF A REPRESENTATIVE NUMBER OF RECEPTACLES)

Comments:

IN NI NP RR IO Items

IN= Inspected, NI= Not Inspected, NP= Not Present, RR= Repair or Replace, IO= Information Only

(1) **Photo of a receptacle being tested.**

A representative number of receptacles throughout the property were tested for power, polarity and grounding according to our standards-of-practice. These receptacles observed to be ok at the time of the inspection unless otherwise noted.



3.7 Item 1(Picture)



3.7 Item 2(Picture)

(2) **Photo of a receptacle being tested.**

A representative number of receptacles throughout the house and garage were tested for power, polarity and grounding according to our standards-of-practice. These receptacles observed to be ok at the time of the inspection unless otherwise noted.

3.8 RECEPTACLE(S) ISSUES

3.9 OPERATION OF GFCI (GROUND FAULT CIRCUIT INTERRUPTERS)

Comments:

(1) All accessible GFCI receptacles were tested and were functioning properly at the time of the inspection unless otherwise reported. Sometimes a tripped GFCI receptacle

IN NI NP RR IO Items

may be difficult to find. If you do not have power at certain receptacles please check all GFCI's and reset the tripped GFCI receptacle. If the GFCI doesn't reset than replacement of the GFCI receptacle will be required.

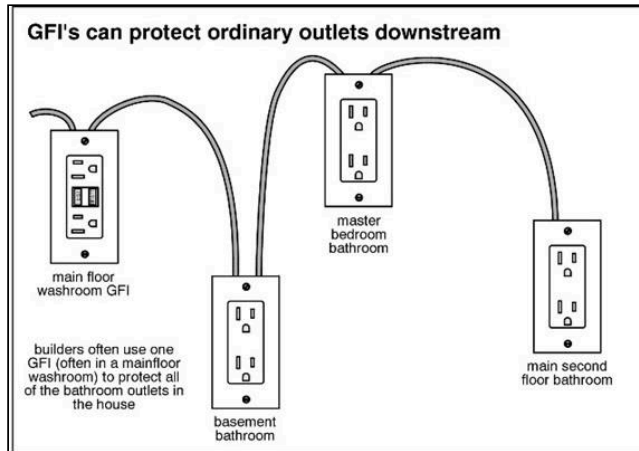

3.9 Item 1(Picture)

(2) We recommend upgrading all receptacles within 6 feet of any plumbing fixtures, outside/ exterior, in the garage, and any non fixed appliance receptacles in the kitchen to GFCI protected receptacles by a qualified licensed electrician for safety.

3.10 JUNCTION BOXES (OBSERVABLE)

Comments:

(1) An open junction box is observed at the pool equipment. All electrical splices must be enclosed in a junction box. We recommend necessary repairs by a qualified person for safety.

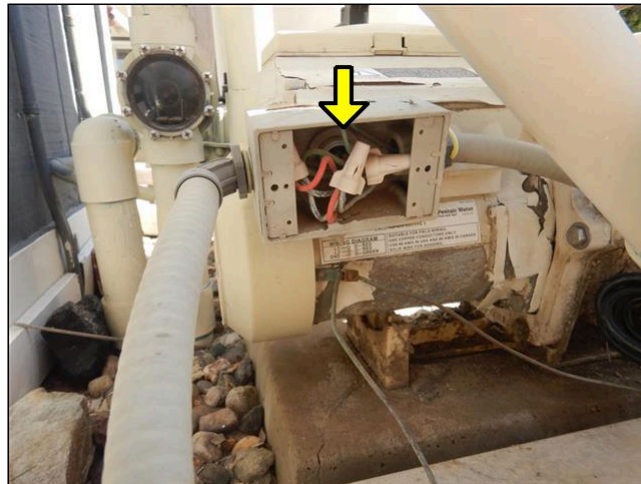

3.10 Item 1(Picture)

IN NI NP RR IO Items

IN= Inspected, NI= Not Inspected, NP= Not Present, RR= Repair or Replace, IO= Information Only

IN NI NP RR IO Items

(2) Open wire splices were observed in the garage. This is non standard. All wire splices connections must be enclosed in a covered junction box. We recommend enclosing the open wire splices in an approved junction box by a qualified licensed electrician.

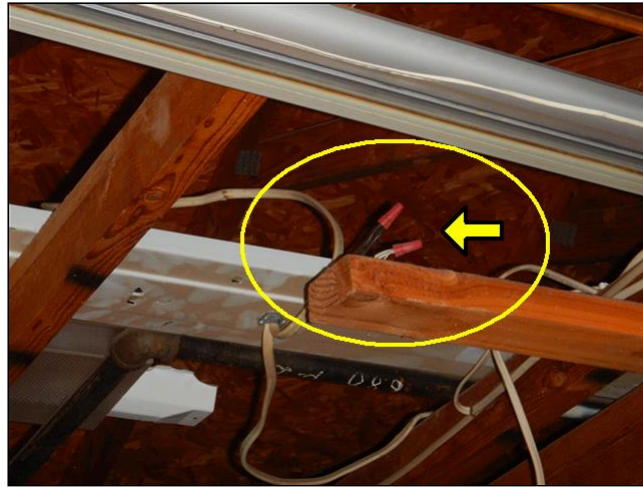

3.10 Item 2(Picture)



3.11 EXTERIOR LIGHTING

EXTERIOR LIGHTING CONTROL: STANDARD SWITCHED

Comments:

(1) The exterior light fixtures were not sealed where the fixture meets the wall. This condition could allow moisture intrusion in this area. We recommend sealing exterior light fixtures where they meet the wall by a qualified person.



3.11 Item 1(Picture)

IN NI NP RR IO Items

IN= Inspected, NI= Not Inspected, NP= Not Present, RR= Repair or Replace, IO= Information Only

IN NI NP RR IO Items

(2) A representative number of exterior lights were tested and were found to be functional at the time of the inspection.

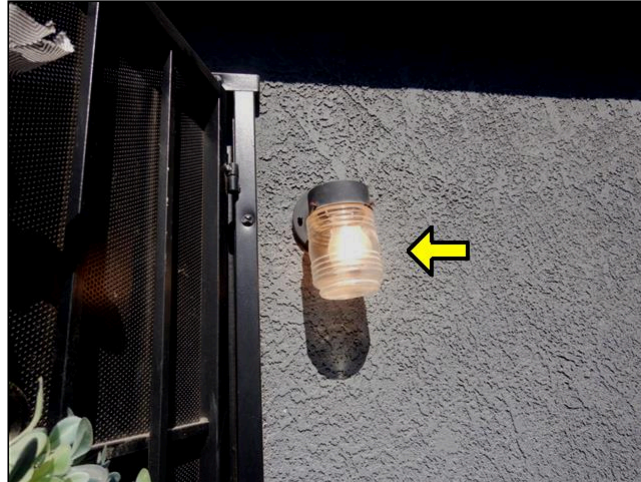

3.11 Item 2(Picture)

3.12 TELEPHONE AND CABLE ENTRANCE

IN NI NP RR IO Items

IN= Inspected, NI= Not Inspected, NP= Not Present, RR= Repair or Replace, IO= Information Only

The electrical system of the home was inspected and reported on with the above information. While the inspector makes every effort to find all areas of concern, some areas can go unnoticed. Outlets were not removed and the inspection was only visual. Any outlet not accessible (behind the refrigerator for example) was not inspected or accessible. Please be aware that the inspector has your best interest in mind. Any repair items mentioned in this report should be considered before purchase. It is recommended that qualified licensed contractors be used in your further inspection or repair issues as it relates to the comments in this inspection report. All electrical concerns/ defects should be considered a safety concern and should be corrected.

4. Garage

The home inspector shall observe: Walls, ceiling, and floors; Steps, stairways, balconies, and railings; Garage door operators; Counters and a representative number of installed cabinets; and A representative number of doors and windows. The home inspector shall: Operate garage doors manually or by using permanently installed controls for any garage door operator; Report whether or not any garage door operator will automatically reverse or stop when meeting reasonable resistance during closing; Operate a representative number of windows and interior doors; and Report signs of abnormal or harmful water penetration into the building or signs of abnormal or harmful condensation on building components. The home inspector is not required to observe: Garage door operator remote control transmitters, Paint, wallpaper, and other finish treatments on the interior walls, ceilings, and floors; Carpeting; or Draperies, blinds, or other window treatments. The home inspector is not required to: Move personal items, panels, furniture, equipment that obstructs access or visibility.



IN= Inspected, NI= Not Inspected, NP= Not Present, RR= Repair or Replace, IO= Information Only

IN NI NP RR IO Items

4.0 GARAGE VEHICLE DOOR(S)

GARAGE VEHICLE DOOR MATERIAL: METAL - PANEL

Comments:

The garage vehicle door hardware including the door, track, and springs appear to be functioning as intended.

4.1 GARAGE VEHICLE DOOR OPENER(S)

Comments:

- (1) Due to the high number of garage door openers that fail to auto-reverse when testing the garage door openers pressure-activated auto-reverse feature which could cause severe damage to the garage door and its related components when it fails to auto-reverse, we did not test the garage door openers pressure-activated auto-reverse feature at the time of the inspection. We recommend having the garage door(s) pressure-activated auto-reverse feature tested prior to the end of your contingency period by a qualified licensed garage door contractor.
- (2) Sensors are in place, were tested and will reverse the garage door.

4.2 GARAGE CEILING

4.3 GARAGE WALLS (INCLUDING FIREWALL SEPERATION)

Comments:

IN NI NP RR IO Items

IN= Inspected, NI= Not Inspected, NP= Not Present, RR= Repair or Replace, IO= Information Only

IN NI NP RR IO Items

(1) Due to occupants personal items, not all areas of the property were visible and accessible at the time of the inspection. Several windows, doors, outlets, walls, flooring, and other areas were obstructed from view and could not be inspected. The home inspector does not move personal items, panels, furniture, equipment, plant life, soil, debris, ect. that obstructs their access or visibility. We recommend that you conduct a careful evaluation during your final walk-through or prior to the end of your contingency period to ensure that there are no hidden defects. All doors, windows, and outlets should be tested and verified for proper operation prior to the end of your contingency period by a qualified person. If any damage is observed we recommend asking the seller about it. We recommend that any damage found be repaired or replaced by a qualified licensed contractor in the appropriate trade.



4.3 Item 1(Picture)

(2) There are several holes observed in the fire wall in the garage. Wherever the garage shares a wall with adjacent living space, the fire-rated sheetrock must be installed and intact for fire resistive performance. We recommend having the holes patched with fire-rated drywall or necessary corrections by a qualified licensed contractor.



4.3 Item 2(Picture)

(3) Hairline cracking was observed at the garage walls in several areas. These hairline cracks are likely due to material shrinkage or settlement of the structure. We recommend prep and paint by a qualified licensed painter.

(4) The walls have typical cosmetic wear. You may wish to view this for yourself and have necessary repairs made as needed by a qualified person.

IN NI NP RR IO Items

IN= Inspected, NI= Not Inspected, NP= Not Present, RR= Repair or Replace, IO= Information Only

IN NI NP RR IO Items

4.4 GARAGE FLOOR/ SLAB

Comments:

Due to stored personal items not all areas throughout the property were visible and accessible at the time of the inspection. The slab and other areas were obstructed from view and could not be inspected. The home inspector does not move personal items, panels, furniture, equipment, plant life, soil, debris, ect. that obstructs their access or visibility. We recommend that you conduct a careful evaluation during your final walk-through or prior to the end of your contingency period to ensure that there are no hidden defects. All doors, windows, and outlets should be tested and verified for proper operation prior to the end of your contingency period by a qualified person. If any damage is observed we recommend asking the seller about it. We recommend that any damage found be repaired or replaced by a qualified licensed contractor in the appropriate trade.

4.5 FIRE-RATED DOOR

Comments:

The door between the house and garage did not have a Fire Rating Certificate or Plate. Without a plate, I could not confirm whether the door meets fire code safety requirements. We recommend further evaluation by a licensed door contractor. The "fire door" is required to meet one of the following characteristics: 1-3/8 inch thick solid wood, 1-3/8 inch thick steel shell door with Honeycomb core, Fire-rated (with certificate plate). If the door is not rated as a fire door we recommend replacing by a qualified licensed door contractor for safety.

4.6 FIRE-DOOR CLOSING DEVICE

Comments:

(1) A self-closing device was present at the fire door and was operating properly when tested. The door closes and latches within 3 seconds without assistance as required.

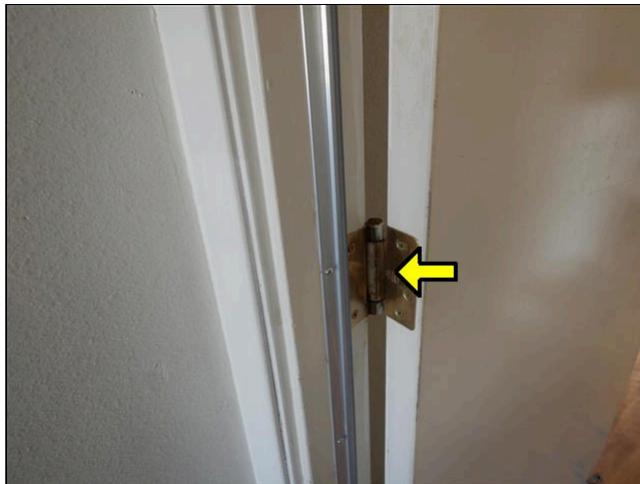

4.6 Item 1(Picture)

IN NI NP RR IO Items

IN= Inspected, NI= Not Inspected, NP= Not Present, RR= Repair or Replace, IO= Information Only

IN NI NP RR IO Items

(2) The door to the garage has a door stopper installed at the bottom of the door. The door stopper defeats the auto closer, which is required. We recommend removal of the door stopper to maintain the integrity of the fire wall and fire door.



4.6 Item 2(Picture)

4.7 GARAGE VENTILATION

4.8 GARAGE PEDESTRIAN DOOR(S)

Comments:

Weather-stripping was not installed at garage pedestrain door. We recommend installing weather-stripping by a qualified person.



4.8 Item 1(Picture)

4.9 OUTLETS/ FIXTURES/ WIRING/ 220V

Comments:

IN NI NP RR IO Items

IN= Inspected, NI= Not Inspected, NP= Not Present, RR= Repair or Replace, IO= Information Only

IN NI NP RR IO Items

(1) There is exposed Romex type wires noted in the garage in several areas. This is a safety concern if used where it could be subject to physical damage. Romex wires are normally used in attics, inside walls, or inside conduit. We recommend necessary corrections by a qualified licensed electrician for safety.

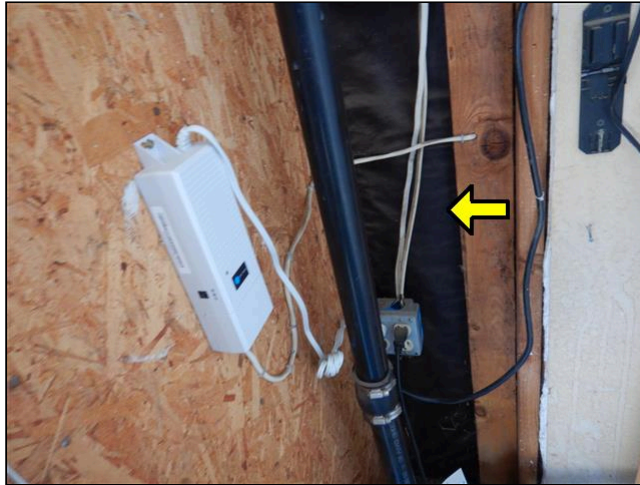

4.9 Item 1(Picture)



4.9 Item 2(Picture)

IN NI NP RR IO Items

IN= Inspected, NI= Not Inspected, NP= Not Present, RR= Repair or Replace, IO= Information Only

IN NI NP RR IO Items

(2) Wire clamps are missing at a junction box located in the garage. This is non standard. A plastic bushing or wire clamp protects and secures the wiring as it enters into the junction box. We recommend installing plastic bushings or wire clamps by a qualified licensed electrician.



4.9 Item 3(Picture)

4.10 GFCI OPERATION

4.11 POLARITY/ GROUNDING (RECEPTACLES)

IN NI NP RR IO Items

IN= Inspected, NI= Not Inspected, NP= Not Present, RR= Repair or Replace, IO= Information Only

The garage was inspected and reported on with the above information. While the inspector makes every effort to find all areas of concern, some areas can go unnoticed. Please be aware that the inspector has your best interest in mind. Any repair items mentioned in this report should be considered before purchase. It is recommended that qualified licensed contractors be used in your further inspection or repair issues as it relates to the comments in this inspection report.

5. Water Heater

The home inspector shall observe: The water heating equipment, including the energy source, venting connections, temperature/pressure-relief (TPR) valves, Watts 210 valves, and seismic bracing, the capacity of the water heating equipment if labeled. The Temperature Pressure Relief (TPR) valve is not tested because the TPR valve is prone to leaking once activated. The inspector is not required to: measure the capacity, temperature, age, life expectancy or adequacy of the water heater, evaluate wait time to obtain hot water at fixtures, or perform testing of any kind to water heater elements.

IN= Inspected, NI= Not Inspected, NP= Not Present, RR= Repair or Replace, IO= Information Only

IN NI NP RR IO Items



5.0 MAIN WATER HEATER (CONTROLS)

WATER HEATER YEAR MANUFACTURED: 2017
WATER HEATER POWER SOURCE: NATURAL GAS
WATER HEATER CAPACITY: 40 GALLON

Comments:

(1) The water heater was inspected and was found to be operational at the time of the inspection. We did not evaluate the efficiency or recover rate of the water heater which is beyond the scope of a general home inspection. If concerned we recommend you consult a licensed plumber. We recommend flushing the water heater routinely as regular maintenance.

(2) **Thermal Photo of the water temperature.**

The temperature of the water was tested using a thermal camera during the inspection and was found to be operating within normal range.



5.0 Item 1(Picture)

IN NI NP RR IO Items

IN= Inspected, NI= Not Inspected, NP= Not Present, RR= Repair or Replace, IO= Information Only

IN NI NP RR IO Items

(3) A carbon monoxide test was performed using a hand help carbon monoxide detector during the inspection while testing the gas water heater. Carbon monoxide was not detected at the time of the inspection.



5.0 Item 2(Picture)

(4) A leak pan is not installed under the water heater. We recommend installing a leak pan under the water heater by a qualified licensed plumber.

(5) A gas leak test was conducted at accessible gas fittings at the water heater using a gas leak detector. There were no gas leaks detected at the time of the inspection.



5.0 Item 3(Picture)

IN NI NP RR IO Items

IN= Inspected, NI= Not Inspected, NP= Not Present, RR= Repair or Replace, IO= Information Only



5.0 Item 4(Picture)

(6) A carbon monoxide test was performed using a hand help carbon monoxide detector during the inspection while testing the gas water heater. Carbon monoxide was not detected at the time of the inspection.

5.1 MAIN WATER HEATER (PLATFORM & STRAPPING)

Comments:

The water heater is adequately strapped as required.

5.2 MAIN WATER HEATER FLUE

5.3 MAIN WATER HEATER (TEMPERATURE & PRESSURE RELIEF VALVE)

IN= Inspected, NI= Not Inspected, NP= Not Present, RR= Repair or Replace, IO= Information Only

The water heater in the home was inspected and reported on with the above information. While the inspector makes every effort to find all areas of concern, some areas can go unnoticed. If the water is turned off or not used for periods of time (like a vacant home waiting for closing) rust or deposits within the pipes can further clog the piping system. Please be aware that the inspector has your best interest in mind. Any repair items mentioned in this report should be considered before purchase. It is recommended that qualified licensed contractors be used in your further inspection or repair issues as it relates to the comments in this inspection report.

6. Interiors

The home inspector shall observe: Walls, ceiling, and floors; Steps, stairways, balconies, and railings; Counters and a representative number of installed cabinets; and A representative number of doors and windows. The home inspector shall: Operate a representative number of windows and interior doors; and Report signs of abnormal or harmful water penetration into the building or signs of abnormal or harmful condensation on building components. The home inspector is not required to observe: Paint, wallpaper, and other finish treatments on the interior walls, ceilings, and floors; Carpeting; or Draperies, blinds, or other window treatments. The home inspector is not required to: Move personal items, panels, furniture, equipment, or anything that obstructs access or visibility. Inspection of the home interior does not include testing for mold, radon, asbestos, lead paint, or other environmental hazards. If concerned we recommend further evaluation by a qualified licensed professional in the appropriate trade prior to the end of your contingency period.



Note: All moisture stains should be investigated until the client is satisfied that the condition is sufficiently understood. Where there are concerns regarding water leaks or infiltration, we recommend that a qualified industrial hygienist evaluate for mold, fungus, or other microbial material prior to the end of your contingency period.

Determining if damage, the presence of organic growths, moisture or wood rot behind walls, base boards, floors and ceiling coverings is beyond the scope of our general home inspection. If you are concerned or believe that these conditions may exist in a nonvisible or concealed area, we recommend that you have this home further examined by a qualified contractor or environmental hygienist prior to the end of your contingency period.

IN= Inspected, NI= Not Inspected, NP= Not Present, RR= Repair or Replace, IO= Information Only

IN NI NP RR IO Items



6.0 INTERIORS (GENERAL COMMENTS)

WALL/ CEILING MATERIAL: SHEETROCK

Comments:

(1) A representative sampling for moisture was preformed at accessible interior walls using a moisture meter. (*areas prone to moisture, such as kitchens, bathrooms, below grade walls, exterior walls with doors/windows*). An elevated moisture was not detected at the time of the inspection.

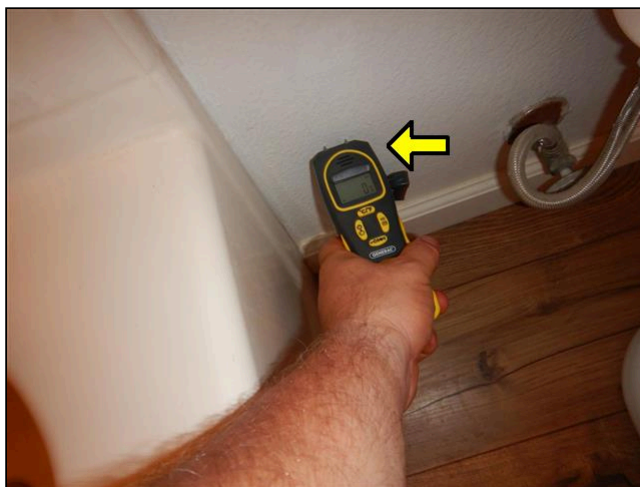

6.0 Item 1(Picture)

(2) Determining if damage, the presence of organic growths, moisture or wood rot behind walls, floors and ceiling coverings is beyond the scope of our general home inspection. If you are concerned or believe that these conditions may exist in a nonvisible or concealed area, we recommend that you have this home further examined by a qualified contractor or environmental hygienist prior to the end of your contingency

IN NI NP RR IO Items

IN= Inspected, NI= Not Inspected, NP= Not Present, RR= Repair or Replace, IO= Information Only

period.

(3) **A WORD ABOUT PHOTOS:** The photos in this report and their associated captions are included as a sampling of the conditions inspected. The photos are intended to clarify selected issues, but are NOT intended to imply their relative importance. Client(s) is advised that NOT all defects will be supported with photos and that NOT all photos taken will be used in the report. If similar defects are found at several locations throughout the property, only a representative number of photos may be shown in this report. Repairs should not be limited to only those areas, but at all instances of the defect(s). Sometimes it is not possible to take a photograph of a defect due to location, lighting, or other obstructions. Numerous photos may be taken of a property but not all will necessarily be included with a corresponding comment in the report. Only a sample number of photos are used and it's MOST important to use and go off the written comment and written information provided in your report. Please reach out to your inspector to request additional photos of an area or item you would want included.

(4) **We did not test the property for asbestos. Testing for asbestos is out of the scope of a general home inspection and was not done by this company at the time of the inspection. If your concerned that the this property may contain asbestos, we recommend that you have the property tested for asbestos prior to the end of your contingency period by a qualified licensed contractor.**

(5) Due to stored personal items not all areas throughout the property were visible and accessible at the time of the inspection. Several windows, doors, outlets, walls, flooring, and other areas were obstructed from view and could not be inspected. The home inspector does not move personal items, panels, furniture, equipment, plant life, soil, debris, ect. that obstructs their access or visibility. We recommend that you conduct a careful evaluation during your final walk-through or prior to the end of your contingency period to ensure that there are no hidden defects. All doors, windows, and outlets should be tested and verified for proper operation prior to the end of your contingency period by a qualified person. If any damage is observed we recommend asking the seller about it. We recommend that any damage found be repaired or replaced by a qualified licensed contractor in the appropriate trade.

6.1 CEILINGS

6.2 WALLS

Comments:

Due to stored personal items not all areas throughout the property were visible and accessible at the time of the inspection. The slab and other areas were obstructed from view and could not be inspected. The home inspector does not move personal items, panels, furniture, equipment, plant life, soil, debris, ect. that obstructs their access or visibility. We recommend that you conduct a careful evaluation during your final walk-through or prior to the end of your contingency period to ensure that there are no hidden defects. All doors, windows, and outlets should be tested and verified for proper operation prior to the end of your contingency period by a qualified person. If any damage is observed we recommend asking the seller about it. We recommend that any damage found be repaired or replaced by a qualified licensed contractor in the appropriate trade.

6.3 FLOOR COVERINGS

6.4 STEPS, STAIRWAYS, RAILINGS

6.5 COUNTERS AND CABINETS (REPRESENTATIVE NUMBER)

Comments:

IN NI NP RR IO Items

(1) Due to stored personal items such as towels, clothing, personal items, hygiene and/ or cleaning products, a full evaluation of the cabinets and closets could not be made. We recommend that you carefully inspect all cabinets and closets prior to the end of your contingency period or during your final walk through. The home inspector does not move personal items, panels, furniture, equipment, plant life, soil, debris, ect. that obstructs their access or visibility. If any damage is observed we recommend asking the seller about it. We recommend that any damage found be repaired or replaced by a qualified licensed contractor in the appropriate trade..

(2) The bottom shelf in the cabinet below the kitchen sink is bowed/ damaged. We recommend necessary repairs or replacement by a qualified licensed qualified contractor.



6.5 Item 1(Picture)

6.6 DOORS (REPRESENTATIVE NUMBER)

Comments:

Several doors are missing. We recommend replacing where needed by a qualified person.

6.7 INFRARED CAMERA INSPECTION FINDINGS

Comments:

IN NI NP RR IO Items

IN= Inspected, NI= Not Inspected, NP= Not Present, RR= Repair or Replace, IO= Information Only

(1) Infrared Camera Thermal Photos.



6.7 Item 1(Picture)

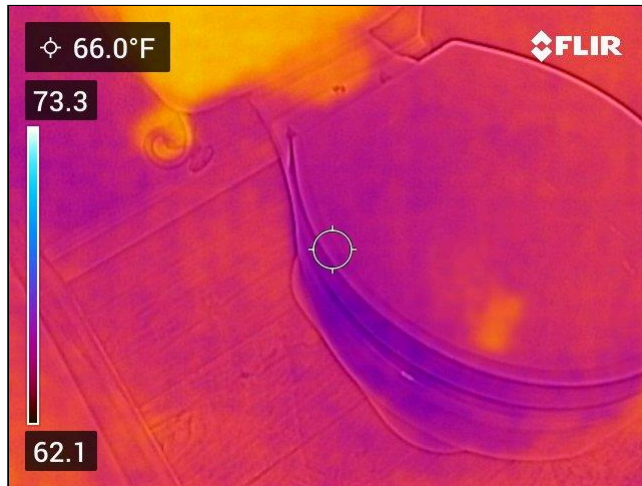

6.7 Item 2(Picture)



6.7 Item 3(Picture)

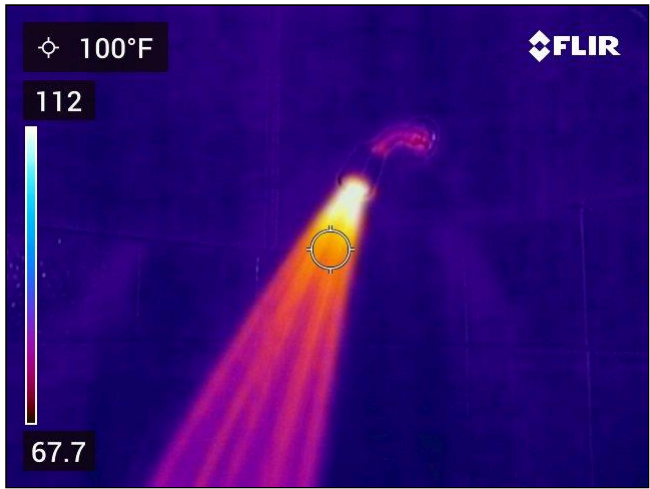

6.7 Item 4(Picture)



6.7 Item 5(Picture)

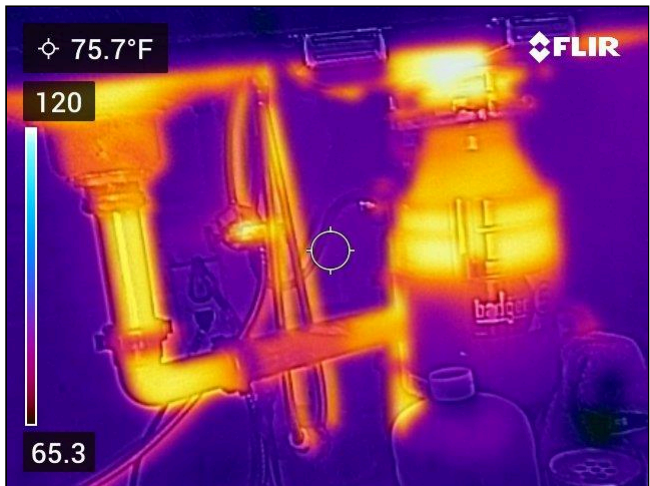

6.7 Item 6(Picture)

(2) An infrared (thermal imaging) scan was performed throughout the property at the time of the inspection using a hand held infrared (thermal imaging) inspection camera. No anomalies were found at the time of the inspection using this camera.

IN NI NP RR IO Items

6.8 SAFETY GLASS (INTERIOR)

6.9 INTERIORS - OTHER

Comments:

(1) Determining the presence of organic growths, moisture or wood rot behind any walls, floors and ceiling coverings is beyond the scope of our general home inspection. We recommend further evaluation by a qualified licensed contractor or a environmental hygienist prior to the end of your contingency if you are concerned.

(2) MAINTENANCE RECOMMENDATION: We recommend re sealing (caulking or grouting) around all sink to counter top junctions and backsplash to countertop junctions, and around all bathroom shower pan(s), curb(s), tub/ shower floor junctions, and adjacent walls throughout the house or where needed by a qualified person to help prevent moisture intrusion in these areas.

(3) MAINTENANCE RECOMMENDATION: We recommend having the property professionally cleaned prior to moving in by a licensed cleaning company.

6.10 ADDITIONS/ MODIFICATIONS

Comments:

The garage appears to have undergone major renovations, remodeling, and additions to the original structure. It is beyond the scope of our general home inspection to verify the existence of permits. We recommend checking city records to verify the existence of permits prior to the end of your contingency period.

IN NI NP RR IO Items

IN= Inspected, NI= Not Inspected, NP= Not Present, RR= Repair or Replace, IO= Information Only

The interior of the home was inspected and reported on with the above information. While the inspector makes every effort to find all areas of concern, some areas can go unnoticed. The inspection did not involve moving furniture and inspecting behind furniture, area rugs or areas obstructed from view. Please be aware that the inspector has your best interest in mind. Any repair items mentioned in this report should be considered before purchase. It is recommended that qualified licensed contractors be used in your further inspection or repair issues as it relates to the comments in this inspection report. Cosmetic deficiencies are considered normal wear and tear and are not reported.

7. Plumbing System



The home inspector shall observe: Interior water supply and distribution system, including: piping materials, supports, and insulation; fixtures and faucets; functional flow; leaks; and cross connections; Interior drain, waste, and vent system, including: traps; drain, waste, and vent piping; piping supports and pipe insulation; leaks; and functional drainage; Hot water systems including: water heating equipment; normal operating controls; automatic safety controls; and chimneys, flues, and vents; Fuel storage and distribution systems including: interior fuel storage equipment, supply piping, venting, and supports; leaks; and Sump pumps. The home inspector shall describe: Water supply and distribution piping materials; Drain, waste, and vent piping materials; Water heating equipment; and Location of main water supply shutoff device. The home inspector shall operate all plumbing fixtures, including their faucets and all exterior faucets attached to the house, except where the flow end of the faucet is connected to an appliance. The home inspector is not required to: State the effectiveness of anti-siphon devices; Determine whether water supply and waste disposal systems are public or private; Operate automatic safety controls; Operate any valve except water closet flush valves, fixture faucets, and hose faucets; Observe: Water conditioning systems; Fire and lawn sprinkler systems; On-site water supply quantity and quality; On-site waste disposal systems; Foundation irrigation systems; Spas, except as to functional flow and functional drainage; Swimming pools; Solar water heating equipment; or Observe the system for proper sizing, design, or use of proper materials unless otherwise agreed upon. Determining whether shower pans are watertight is beyond the scope of the inspection.

Laundry Note: Washers and dryers are not moved or tested during the inspection. The washer drain line and the dryer vent duct are not tested. Best practices for washer and dryer installation include the following recommendations: Use braided metallic water hoses to reduce the potential of leaks at the washing machine. Use flexible metal dryer vent connector. Use a half inch appliance connector and gas valve for all newer gas dryers. Installation of a drain pan under the washing machine with a drain pipe terminating at the exterior.

Underground Gas Pipe Note: Determining if the below ground gas pipes leak is beyond the scope of a home inspection. If concerned we recommend further evaluation of all underground gas piping by a licensed plumbing contractor prior to the end of your contingency period. Note: While the inspector attempts to discover gas leaks at the accessible gas fittings and appliances while using a gas leak detector, some leaks can go undetected.

Home inspectors do not operate (turn) any water supply shut off valves at any property such as angle stops (the type under sinks and toilets), laundry hose spigots, water heater supply valves, or main water shut off valves at the meter. Home inspectors do not test clothes washer drains or stand pipes, or flood test the over-flow drains at tubs and sinks in accordance with industry standards of practice. If you have questions about these exclusions, please contact your home inspector.

IN= Inspected, NI= Not Inspected, NP= Not Present, RR= Repair or Replace, IO= Information Only

IN NI NP RR IO Items



7.0 DRAIN, WASTE, AND VENT SYSTEMS

PLUMBING WASTE (OBSERVED INSIDE THE HOME): ABS, PARTIALLY VISIBLE

GAS DISTRIBUTION: RIGID IRON PIPE, PARTIALLY VISIBLE

WASHER DRAIN SIZE: 2" DIAMETER

Comments:

At the time of the inspection we evaluated all drain pipes by running water through every drain that has an active fixture while observing its draw and watching for blockages or slow draining. Kitchen and bathroom fixtures were tested for an extended period of time during the inspection. We did not test the laundry stand pipe if a washing machine is connected. A video-scan of the drains and main line can only help determine the actual condition(s) of these drain pipes. We recommend having a sewer camera inspection conducted to help determine the condition of the pipes prior to the end of your contingency period.



7.1 WATER SUPPLY, DISTRIBUTION SYSTEMS

WATER SOURCE: PUBLIC

PLUMBING WATER DISTRIBUTION (INSIDE THE HOME): COPPER, PARTIALLY VISIBLE

IN NI NP RR IO Items

IN= Inspected, NI= Not Inspected, NP= Not Present, RR= Repair or Replace, IO= Information Only

IN NI NP RR IO Items

7.2 WATER PRESSURE/ REGULATOR

WATER PRESSURE (PSI): 80-85 PSI (HIGH)

Comments:

The water pressure was checked with a water pressure gauge and was measured to be higher than 80 PSI at the time of the inspection. This is to high and corrections are needed. We recommend further evaluation by a qualified licensed plumber for necessary repairs or corrections.

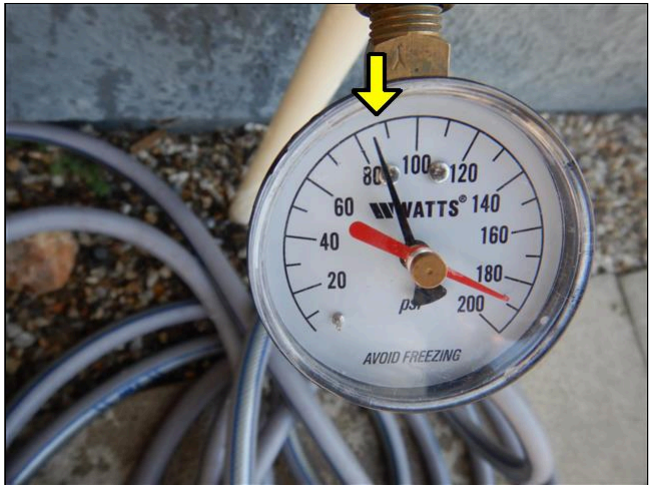

7.2 Item 1(Picture)

7.3 HOSE SPIGOT(S)

Comments:

IN NI NP RR IO Items

IN= Inspected, NI= Not Inspected, NP= Not Present, RR= Repair or Replace, IO= Information Only

IN NI NP RR IO Items

- (1) The accessible hose spigots were tested and were found to be operational at the time of the inspection. Note: Some hose spigots may leak or drip when a watering hose is connected due to back pressure.
- (2) The exterior hose spigots do not have anti-siphon or anti-backflow devices installed on them. These anti-siphon or anti-backflow devices help prevent contaminated water from flowing back into the the house water supply system. We recommend installing anti-siphon or anti-backflow devices at the every exterior hose spigots by a qualified person.



7.3 Item 1(Picture)

7.4 GAS/ FUEL STORAGE AND DISTRIBUTION SYSTEMS

IN NI NP RR IO Items

IN= Inspected, NI= Not Inspected, NP= Not Present, RR= Repair or Replace, IO= Information Only

The plumbing in the home was inspected and reported on with the above information. While the inspector makes every effort to find all areas of concern, some areas can go unnoticed. Washing machine drain line for example cannot be checked for leaks or the ability to handle the volume during drain cycle. The water supply and waste line piping that is concealed within inaccessible areas such as covered walls and concrete slab floors was not evaluated. Older homes with galvanized supply lines or cast iron drain lines can be obstructed and barely working during an inspection but then fails under heavy use. If the water is turned off or not used for periods of time (like a vacant home waiting for closing) rust or deposits within the pipes can further clog the piping system. Please be aware that the inspector has your best interest in mind. Any repair items mentioned in this report should be considered before purchase. It is recommended that qualified licensed contractors be used in your further inspection or repair issues as it relates to the comments in this inspection report.

8(A) . Bathroom(s) / Hall Bathroom

The bathroom(s) and it's related components were inspected and appeared to be functioning/ operating as intended at the time of the inspection unless other wise commented on in the appropriate bathroom section(s).



MAINTENANCE RECOMMENDATION: We recommend re sealing (caulking or grouting) around all sink to counter top junctions and backsplash to countertop junctions, and around all bathroom shower pan(s), curb(s), tub/ shower floor junctions, and adjacent walls throughout the house or where needed by a qualified person.

IN= Inspected, NI= Not Inspected, NP= Not Present, RR= Repair or Replace, IO= Information Only

IN NI NP RR IO Items

8.0.A TUB/ SHOWER ENCLOSURE

Comments:

The tub/ shower faucet valve does not back stop. This condition allows the tub faucet valve to turn past the off position without stopping. We recommend necessary repairs or replacement by a qualified licensed plumber.



8.0.A Item 1(Picture)

8.1.A BATHROOM OTHER

Comments:

MAINTENANCE RECOMMENDATION: We recommend re sealing (caulking or grouting) around all sink to counter top junctions and backsplash to countertop junctions, and around all bathroom shower pan(s), curb(s), tub/ shower floor junctions, and adjacent walls throughout the house or where needed by a qualified person to help prevent moisture intrusion in these areas.

IN NI NP RR IO Items

IN= Inspected, NI= Not Inspected, NP= Not Present, RR= Repair or Replace, IO= Information Only

The bathroom(s) were inspected and reported on with the above information. While the inspector makes every effort to find all areas of concern, some areas can go unnoticed. The inspection did not involve moving personal property, furniture and inspecting behind furniture, area rugs or areas obstructed from view. Please be aware that the inspector has your best interest in mind. Any repair items mentioned in this report should be considered before purchase. It is recommended that qualified licensed contractors be used in your further inspection or repair issues as it relates to the comments in this inspection report. Cosmetic deficiencies are considered normal wear and tear and are not reported.

8(B) . Bathroom(s) / Master Bathroom

The bathroom(s) and it's related components were inspected and appeared to be functioning/ operating as intended at the time of the inspection unless other wise commented on in the appropriate bathroom section(s).



MAINTENANCE RECOMMENDATION: We recommend re sealing (caulking or grouting) around all sink to counter top junctions and backsplash to countertop junctions, and around all bathroom shower pan(s), curb(s), tub/ shower floor junctions, and adjacent walls throughout the house or where needed by a qualified person.

IN= Inspected, NI= Not Inspected, NP= Not Present, RR= Repair or Replace, IO= Information Only

IN NI NP RR IO Items

8.0.B SINK(S)

Comments:

The sink stopper was inoperable when tested. We recommend necessary repairs or replacement by a qualified person.



8.0.B Item 1(Picture)

8.1.B SHOWER

Comments:

IN NI NP RR IO Items

IN= Inspected, NI= Not Inspected, NP= Not Present, RR= Repair or Replace, IO= Information Only

IN NI NP RR IO Items

Non-standard height was observed at the shower curb/ threshold. Normally a shower curb/ threshold is a minimum 2" above the drain. (usually a 4" threshold, with a maximum allowable of 9"). We recommend further evaluation by a qualified licensed contractor and repairs made as needed.



8.1.B Item 1(Picture)



8.2.B BATHROOM OTHER

Comments:

MAINTENANCE RECOMMENDATION: We recommend re sealing (caulking or grouting) around all sink to counter top junctions and backsplash to countertop junctions, and around all bathroom shower pan(s), curb(s), tub/ shower floor junctions, and adjacent walls throughout the house or where needed by a qualified person to help prevent moisture intrusion in these areas.

IN NI NP RR IO Items

IN= Inspected, NI= Not Inspected, NP= Not Present, RR= Repair or Replace, IO= Information Only

The bathroom(s) were inspected and reported on with the above information. While the inspector makes every effort to find all areas of concern, some areas can go unnoticed. The inspection did not involve moving personal property, furniture and inspecting behind furniture, area rugs or areas obstructed from view. Please be aware that the inspector has your best interest in mind. Any repair items mentioned in this report should be considered before purchase. It is recommended that qualified licensed contractors be used in your further inspection or repair issues as it relates to the comments in this inspection report. Cosmetic deficiencies are considered normal wear and tear and are not reported.

9. Laundry

IN= Inspected, NI= Not Inspected, NP= Not Present, RR= Repair or Replace, IO= Information Only

IN NI NP RR IO Items

9.0 WASHING MACHINE/ DRYER CONNECTION(S)

DRYER POWER SOURCE: GAS ONLY

9.1 CLOTHES DRYER VENT

DRYER VENT: FOIL

Comments:

(1) The dryer is equipped with a foil, accordion-type duct. The U.S. Consumer Product Safety Commission considers these types of ducts to be unsafe and a fire hazard. The flexible foil type duct can more easily trap lint and is more susceptible to kinks or crushing, which can greatly reduce the airflow. We recommend replacing the duct with a rigid or corrugated semi-rigid metal duct.

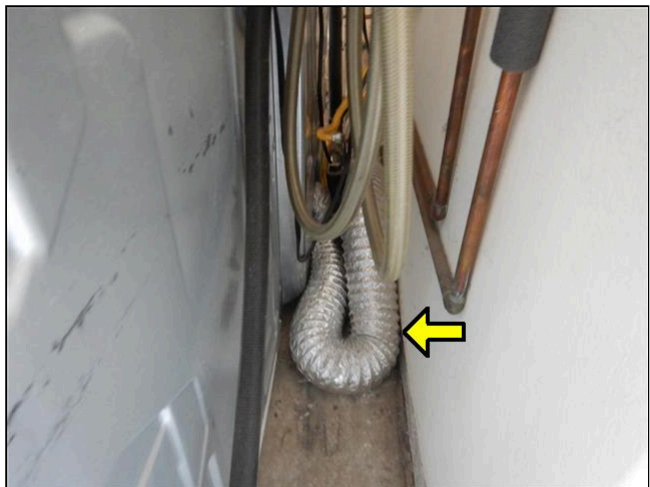

9.1 Item 1(Picture)

(2) We recommend having the dryer vent cleaned by a qualified person.

(3) We recommend having the dryer vent cleaned by a qualified person.

9.2 LAUNDRY OTHER

Comments:

The clothes washer and dryer are not part of our general inspection and were not inspected or commented on. If concerned about there serviceability and functionality we recommend further evaluation by a qualified licensed appliance contractor prior to the end of your contingency period.

IN NI NP RR IO Items

IN= Inspected, NI= Not Inspected, NP= Not Present, RR= Repair or Replace, IO= Information Only

The laundry room/ area inspected and reported on with the above information. While the inspector makes every effort to find all areas of concern, some areas can go unnoticed. The inspection did not involve moving personal property, furniture, washing machine/ dryer and inspecting behind furniture, area rugs or areas obstructed from view. Please be aware that the inspector has your best interest in mind. Any repair items mentioned in this report should be considered before purchase. It is recommended that qualified licensed contractors be used in your further inspection or repair issues as it relates to the comments in this inspection report. Cosmetic deficiencies are considered normal wear and tear and are not reported.

10. Fireplaces/ Chimneys

This inspection of the fireplace/ chimney is limited to the readily visible portions only. The inner reaches of a chimney flue are not visually accessible and the view from the top or bottom is not adequate to discover possible deficiencies or damage with in our general home inspection. We recommend that a National Fire Protection Association (NFPA) 211 Standard, Level II inspection by a qualified licensed professional be preformed prior to the end of your contingency period. They can use specialized tools, testing procedures, mirrors, and video cameras to thoroughly evaluate the fireplace system. We do not light the gas or start a fire, or check for proper drafting.

We recommend that all fireplaces be cleaned and inspected by a qualified licensed person prior to using and on a regular basis to insure safe operation.

IN= Inspected, NI= Not Inspected, NP= Not Present, RR= Repair or Replace, IO= Information Only

IN NI NP RR IO Items

10.0 CHIMNEY(S)

FIRE PLACE TYPES: GAS STUB

NUMBER OF FIREPLACE(S): ONE

Comments:

(1) We recommend having the fireplace and chimney cleaned and inspected by a licensed chimney sweep for safety prior to using.



10.0 Item 1(Picture)

(2) The chimney liner was not inspected by our company. We recommend a qualified chimney contractor inspect for safety if concerned.

10.1 FIREPLACE(S)

Comments:

The spark screen at the fireplace is missing. We recommend replacement.

10.2 DAMPER/ DAMPER CLAMP

10.3 HEARTH/ MANTLE

IN NI NP RR IO Items

IN= Inspected, NI= Not Inspected, NP= Not Present, RR= Repair or Replace, IO= Information Only

The fireplace was inspected and reported on with the above information. While the inspector makes every effort to find all areas of concern, some areas can go unnoticed. Please be aware that the inspector has your best interest in mind. Any repair items mentioned in this report should be considered before purchase. It is recommended that qualified licensed contractors be used in your further inspection or repair issues as it relates to the comments in this inspection report.

11. Detectors, Safety, Security



IN= Inspected, NI= Not Inspected, NP= Not Present, RR= Repair or Replace, IO= Information Only

IN NI NP RR IO Items

11.0 SMOKE DETECTORS

11.1 CARBON MONOXIDE DETECTOR(S)

Comments:

(1) **Photo of carbon monoxide detector(s).**



11.1 Item 1(Picture)

(2) The quantity of Carbon Monoxide detectors that are required to be installed varies with each house. Larger houses, or those with multiple levels are required to have more CO detectors. A Carbon Monoxide detector is required on each level of a multi-level house and adjacent to each cluster of bedrooms. We recommend installing additional Carbon Monoxide detectors where needed.

11.2 SAFETY - OTHER

Comments:

(1) All smoke detector should be tested upon moving into home, and every six months or per manufactures instructions. Smoke detectors should be replaced when they reach 10 years of age as their sensor becomes less effective over time or per manufactures instructions.

(2) All carbon monoxide detectors should be tested upon moving into home, and every six months or per manufactures instructions. Carbon monoxide detectors should be replaced per manufactures instructions.

IN NI NP RR IO Items

IN= Inspected, NI= Not Inspected, NP= Not Present, RR= Repair or Replace, IO= Information Only

12. Heating Equipment

The home inspector shall observe permanently installed heating and cooling systems including: Heating equipment; Cooling Equipment that is central to home; Normal operating controls; Automatic safety controls; Chimneys, flues, and vents, where readily visible; Solid fuel heating devices; Heat distribution systems including fans, pumps, ducts and piping, with supports, insulation, air filters, registers, radiators, fan coil units, convectors; and the presence of an installed heat source in each room. The home inspector shall describe: Energy source; and Heating equipment and distribution type. The home inspector shall operate the systems using normal operating controls. The home inspector shall open readily openable access panels provided by the manufacturer or installer for routine homeowner maintenance. The home inspector is not required to: Operate heating systems when weather conditions or other circumstances may cause equipment damage; Operate automatic safety controls; Ignite or extinguish solid fuel fires; or Observe: The interior of flues; the interior of ducts; Fireplace insert flue connections; Humidifiers; Electronic air filters; or The uniformity or adequacy of heat supply to the various rooms.



Note: A limited visual inspection can not adequately evaluate the heat exchanger for cracks and holes. Most areas of the heat exchanger are not visible without dismantling the furnace. Dismantling the furnace is beyond the scope of our general home inspection. Evaluation of the heat exchanger is expressly excluded. Evaluating the adequacy, efficiency, or even distribution of air throughout the home is not part of the inspection. Thermostats are not checked for calibration or programmable features, interior of the ducts are not inspected for cleanliness and if concerned about the cleanliness we recommend having them checked and cleaned by a licensed HVAC contractor prior to the end of your contingency period.

IN= Inspected, NI= Not Inspected, NP= Not Present, RR= Repair or Replace, IO= Information Only

IN NI NP RR IO Items

12.0 HEATING EQUIPMENT

HEAT TYPE: FORCED AIR

NUMBER OF HEAT SYSTEMS (EXCLUDING WOOD): ONE

ENERGY SOURCE: NATURAL GAS

Comments:

(1) The furnace was tested and was functional/ operated at the time of the inspection.



12.0 Item 1(Picture)

IN NI NP RR IO Items

IN= Inspected, NI= Not Inspected, NP= Not Present, RR= Repair or Replace, IO= Information Only

(2) Infrared Thermal photo of the furnace(s) being tested.

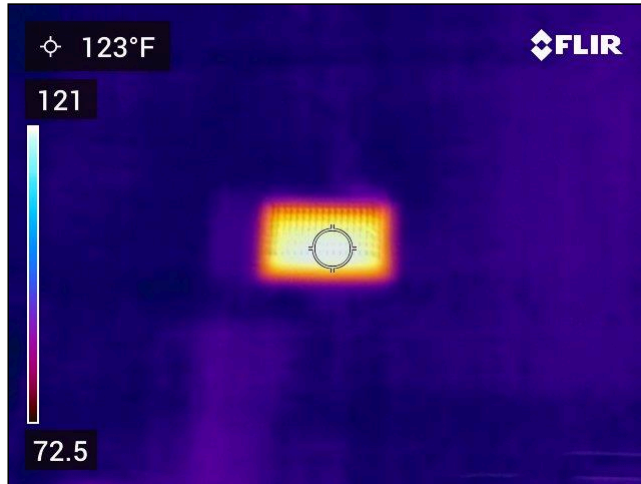

12.0 Item 2(Picture)

(3) The gas supply pipe at the furnace did not contain a drip leg/ sediment trap. This may have been standard at the time of installation but now is highly recommended. The purpose of a drip leg is to help prevent sediment/ debris from entering and clogging the furnace gas valve which could cause the furnace to shut down. We recommend having a drip leg installed by a qualified licensed HVAC contractor.

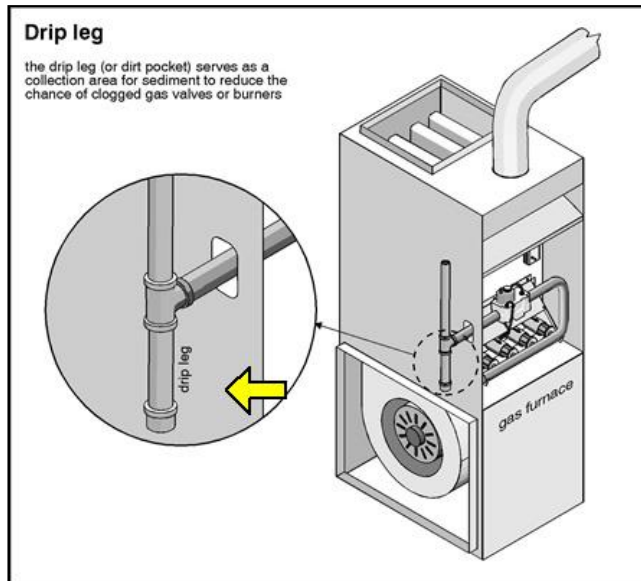

12.0 Item 3(Picture)

IN NI NP RR IO Items

- (4) A gas leak test was conducted at accessible gas fittings at the furnace using a gas leak detector. There were no gas leaks detected at the time of the inspection.
- (5) A carbon monoxide test was performed using a hand help carbon monoxide detector during the inspection while testing the gas furnace. Carbon monoxide was not detected at the time of the inspection.
- (6) The furnace is not sealed around the base of the unit. We recommend having the base of the furnace be sealed by a qualified person.
- (7) **Infrared Thermal photo of the furnace(s) being tested.**

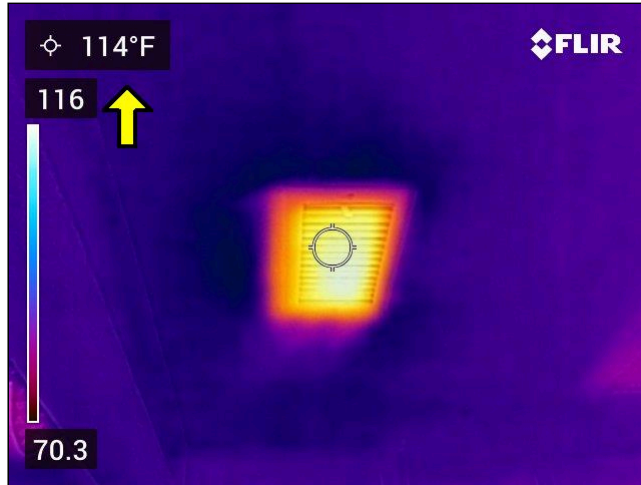

12.0 Item 4(Picture)



12.1 THERMOSTAT(S)

Comments:

The thermostat was operational when used to operate the HVAC system at the time of the inspection. Programmable thermostats are not adjusted and no testing is done to check the accuracy or programmed settings of the thermostat. If concerned we recommend verifying proper operation of the programmable settings prior to the end of your contingency period by a qualified person.

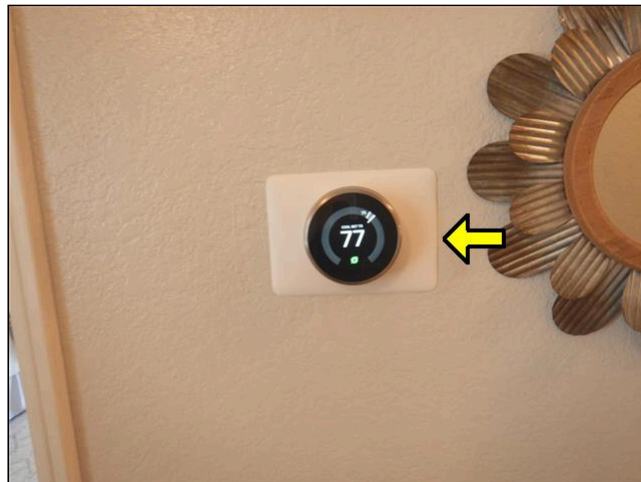

12.1 Item 1(Picture)



12.2 VENTS AND FLUES (HEATING SYSTEM)

IN NI NP RR IO Items

IN= Inspected, NI= Not Inspected, NP= Not Present, RR= Repair or Replace, IO= Information Only

IN NI NP RR IO Items



12.3 DISTRIBUTION SYSTEMS (INCLUDING FANS, PUMPS, DUCTS, INSULATION, FILTERS, REGISTERS)

DUCTWORK: INSULATED

IN NI NP RR IO Items

IN= Inspected, NI= Not Inspected, NP= Not Present, RR= Repair or Replace, IO= Information Only

The heating and cooling system of this home was inspected and reported on with the above information. While the inspector makes every effort to find all areas of concern, some areas can go unnoticed. The inspection is not meant to be technically exhaustive. The inspection does not involve removal and inspection behind service door or dismantling that would otherwise reveal something only a licensed heat contractor would discover. Please be aware that the inspector has your best interest in mind. Any repair items mentioned in this report should be considered before purchase. It is recommended that qualified licensed contractors be used in your further inspection or repair issues as it relates to the comments in this inspection report.

13. Cooling Equipment

The home inspector shall observe: Central air conditioning and permanently installed cooling systems including: Cooling and air handling equipment; and Normal operating controls. Distribution systems including: Fans, pumps, ducts and piping, with associated supports, dampers, insulation, air filters, registers, fan-coil units; and The presence of an installed cooling source in each room. The home inspector shall describe: Energy sources; and Cooling equipment type. The home inspector shall operate the systems using normal operating controls. The home inspector shall open readily openable access panels provided by the manufacturer or installer for routine homeowner maintenance. The home inspector is not required to: Observe window air conditioners or operate cooling systems when weather conditions or other circumstances may cause equipment damage; Observe non-central air conditioners; or Observe the uniformity or adequacy of cool-air supply to the various rooms.



IN= Inspected, NI= Not Inspected, NP= Not Present, RR= Repair or Replace, IO= Information Only

IN NI NP RR IO Items

13.0 COOLING EQUIPMENT

COOLING EQUIPMENT TYPE: AIR CONDITIONER

NUMBER OF A/C UNITS: ONE

CONDENSER AGE: LESS THAN 15 YEARS

Comments:

- (1) **Photo of the A/C unit(s).**



13.0 Item 1(Picture)

IN NI NP RR IO Items

IN= Inspected, NI= Not Inspected, NP= Not Present, RR= Repair or Replace, IO= Information Only

IN NI NP RR IO Items

(2) An ambient air test was performed by using a thermal camera on the AC system to determine if the difference in temperatures of the supply and return air were between 14 degrees and 22 degrees which indicates that the AC system is cooling as intended.

The air supplied to the room was measured around **48 degrees**.

The air returning to the system (return) was measured at **69 degrees**.

This indicates that the range in temperature drop is normal. This is not an exhaustive test and cannot predict the performance of the AC systems on extremely hot or humid days.

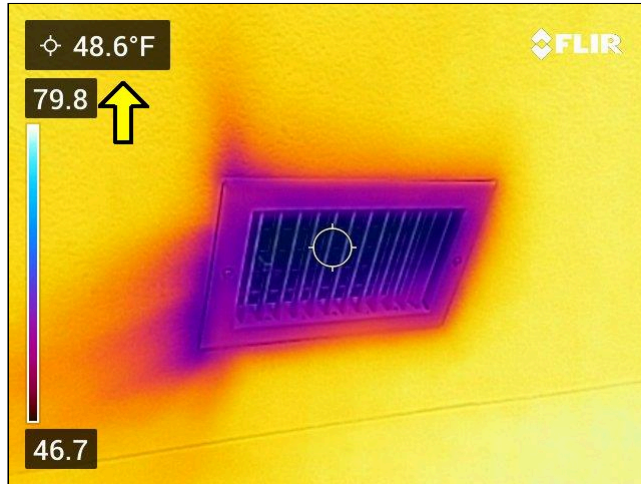

13.0 Item 2(Picture)



13.0 Item 3(Picture)

IN NI NP RR IO Items

IN= Inspected, NI= Not Inspected, NP= Not Present, RR= Repair or Replace, IO= Information Only

IN NI NP RR IO Items

- (3) The condensers are not strapped to pad(s). Most manufacturers installation instructions require strapping condensers to the pads. Movement of the units due to internal vibration (or earthquake) can damage the refrigerant lines and their connections. We recommend necessary repairs a licensed HVAC contractor.
- (4) The AC unit electrical conduit is not secured to the wall as required. We recommend having the AC unit conduit secured to the wall by a qualified person.
- (5) The AC unit electrical conduit is in contact with the ground. This is non-standard. We recommend necessary corrections by a qualified person.

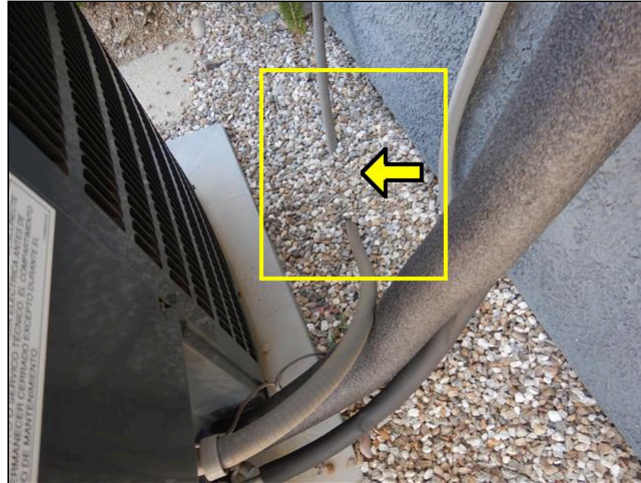

13.0 Item 4(Picture)



13.1 CONDENSATE EQUIPMENT

Comments:

- (1) There is no secondary AC condensation drain installed. This may have been acceptable at time of installation. However, today a secondary drain or alternate device is required to prevent damage in case of a clog in the primary drain. We recommend installing a secondary drain or alternate device by a qualified licensed HVAC contractor.
- (2) A vented trap was not installed in the condensation drain line. A vented trap must be installed in the condensation drain line to prevent vapor lock and possible condensation leaks in the house. We recommend installation of a vented trap by a qualified licensed HVAC contractor.

IN NI NP RR IO Items

IN= Inspected, NI= Not Inspected, NP= Not Present, RR= Repair or Replace, IO= Information Only

The cooling system of this home was inspected and reported on with the above information. While the inspector makes every effort to find all areas of concern, some areas can go unnoticed. The inspection is not meant to be technically exhaustive. The inspection does not involve removal and inspection behind service door or dismantling that would otherwise reveal something only a licensed HVAC contractor would discover (Heating, Ventilation, and Air Conditioning). Please be aware that the inspector has your best interest in mind. Any repair items mentioned in this report should be considered before purchase. It is recommended that qualified licensed contractors be used in your further inspection or repair issues as it relates to the comments in this inspection report.

14. Ventilation and Insulation

The home inspector shall observe: Insulation and vapor retarders in unfinished spaces; Ventilation of attics and foundation areas; Kitchen, bathroom, and laundry venting systems; and the operation of any readily accessible attic ventilation fan, and, when temperature permits, the operation of any readily accessible thermostatic control. The home inspector shall describe: Insulation in unfinished spaces; and Absence of insulation in unfinished space at conditioned surfaces. The home inspector shall: Move insulation where readily visible evidence indicates the need to do so; and Move insulation where chimneys penetrate roofs, where plumbing drain/waste pipes penetrate floors, adjacent to earth filled stoops or porches, and at exterior doors. The home inspector is not required to report on: Concealed insulation and vapor retarders; or Venting equipment that is integral with household appliances.



IN= Inspected, NI= Not Inspected, NP= Not Present, RR= Repair or Replace, IO= Information Only

IN NI NP RR IO Items

14.0 INSULATION IN THE ATTIC SPACE

ATTIC INSULATION: FIBERGLASS BATT
R-VALUE (APPROXIMATE): R-19 OR BETTER

Comments:

- (1) [Photo of the insulation.](#)



14.0 Item 1(Picture)

- (2) The insulation in the attic appears to be functioning as intended.
- (3) The attic space access hatch cover is not insulated. We recommend insulating the attic access hatch cover to reduce unwanted heat loss/gain by a qualified person.

14.1 BATHROOM VENTING

14.2 VENTILATION OF THE ATTIC SPACE

ATTIC VENTILATION: GABLE AND SOFFIT VENTS

14.3 WHOLE HOUSE FAN

Comments:

IN NI NP RR IO Items

IN= Inspected, NI= Not Inspected, NP= Not Present, RR= Repair or Replace, IO= Information Only

IN NI NP RR IO Items

The whole house fan did operate when tested at the time of the inspection.



14.3 Item 1(Picture)

IN NI NP RR IO Items

IN= Inspected, NI= Not Inspected, NP= Not Present, RR= Repair or Replace, IO= Information Only

The insulation and ventilation of the home was inspected and reported on with the above information. While the inspector makes every effort to find all areas of concern, some areas can go unnoticed. Venting of exhaust fans or clothes dryer cannot be fully inspected and bends or obstructions can occur without being accessible or visible (behind wall and ceiling coverings). Only insulation that is visible was inspected. Please be aware that the inspector has your best interest in mind. Any repair items mentioned in this report should be considered before purchase. It is recommended that qualified licensed contractors be used in your further inspection or repair issues as it relates to the comments in this inspection report.

15. Structural Components

The Home Inspector shall observe structural components including foundations, floors, walls, columns or piers, ceilings and roof. The home inspector shall describe the type of Foundation, floor structure, wall structure, columns or piers, ceiling structure, roof structure. The home inspector shall: Probe structural components where deterioration is suspected; Enter under floor crawl spaces, basements, and attic spaces except when access is obstructed, when entry could damage the property, or when dangerous or adverse situations are suspected; Report the methods used to observe under floor crawl spaces and attics; and Report signs of abnormal or harmful water penetration into the building or signs of abnormal or harmful condensation on building components. The home inspector is not required to: Enter any area or perform any procedure that may damage the property or its components or be dangerous to or adversely effect the health of the home inspector or other persons.



Note: Much of the home structure is hidden behind exterior and interior roof, floor, wall, and ceiling coverings, or is buried underground. Because the General Home Inspection is limited to visual and non-invasive methods, this report may not identify all structural deficiencies. Identification of portions of the wall structure not directly visible requires logical assumptions on the part of the Inspector that are based on the Inspectors past experience and knowledge of common building practices.

Upon observing indications that structural problems may exist that are not readily visible, or the evaluation of which lies beyond the Inspector's expertise, the inspector may recommend evaluation or testing by a specialist that may include invasive measures, which would require homeowner permission.

IN= Inspected, NI= Not Inspected, NP= Not Present, RR= Repair or Replace, IO= Information Only

IN NI NP RR IO Items

15.0 STRUCTURE (GENERAL INFORMATIONAL)

ATTIC ACCESS/ LOCATION: SCUTTLE HOLE

WALL STRUCTURE: WOOD STUDS

Comments:

At the time of the inspection, the Inspector observed no visual defects in the condition of the homes structure. A general home inspection does not include the evaluation of any structural components that are hidden behind floors, walls, or ceiling coverings. Such as anchor bolts, shear walls and seismic hardware, but is visual and non-invasive only.

15.1 ROOF STRUCTURE AND ATTIC SPACE

ROOF TYPE: GABLE

ROOF STRUCTURE: ENGINEERED WOOD TRUSSES, PLYWOOD SHEATHING

METHOD USED TO OBSERVE THE ATTIC SPACE: FROM THE ENTRY

Comments:

Due to the structure of the roof/ framing and forced air handling components, some areas of the attic space could not be inspected.

15.2 SLAB

1ST LEVEL FLOOR STRUCTURE: SLAB - OLD

Comments:

- (1) The concrete slab throughout the property was not visible to inspect. Home Inspectors do not move stored items or lift floor coverings which may conceal cracks or other concealed defects that the inspector cannot see. This should not deter you from further evaluation by a qualified licensed foundation contractor or structural engineer prior to the end of your contingency period if concerned about the slab. It would be your (clients) responsibility to arrange this and for lifting or removing of the flooring.
- (2) Concrete slabs are prone to cracking. Home Inspectors do not move stored items or lift floor coverings which may conceal cracks that the inspector cannot see. This should

IN NI NP RR IO Items

IN= Inspected, NI= Not Inspected, NP= Not Present, RR= Repair or Replace, IO= Information Only

IN NI NP RR IO Items

not deter you from further evaluation by a qualified licensed foundation contractor or structural engineer if concerned about the slab. It would be your (clients) responsibility to arrange this and for lifting or removing of the flooring.



15.3 FOUNDATION

FOUNDATION: POURED CONCRETE



15.4 FOUNDATION BOLT(S)

FOUNDATION BOLTS: NOT VISIBLE

Comments:

Foundation bolts are not visible due to finished wall materials. However, due to the age of the house foundation bolts are likely to be present.

IN NI NP RR IO Items

IN= Inspected, NI= Not Inspected, NP= Not Present, RR= Repair or Replace, IO= Information Only

The structure of the home was inspected and reported on with the above information. While the inspector makes every effort to find all areas of concern, some areas can go unnoticed. Please be aware that the inspector has your best interest in mind. Any repair items mentioned in this report should be considered before purchase. It is recommended that qualified licensed contractors be used in your further inspection or repair issues as it relates to the comments in this inspection report.

16. Built-In Kitchen Appliances

The home inspector shall observe and operate the basic functions of the following kitchen appliances: Permanently installed dishwasher, through its normal cycle; Range, cook top, and permanently installed oven; Trash compactor; Garbage disposal; Ventilation equipment or range hood; and Permanently installed microwave oven. Inspection of built-in appliances is limited. It does not include dismantling and inspection of internal parts. The home inspector is not required to observe: Clocks, timers, self-cleaning oven function, or thermostats for calibration or automatic operation; Non built-in appliances; or Refrigeration units. The home inspector is not required to operate: Appliances in use; or Any appliance that is shut down or otherwise inoperable, or determine the effectiveness or life remaining of any built-in appliances.



IN= Inspected, NI= Not Inspected, NP= Not Present, RR= Repair or Replace, IO= Information Only

IN NI NP RR IO Items

16.0 MICROWAVE (BUILT-IN)

Comments:

- (1) **Photo of microwave being tested.**

The built in microwave was tested with a microwave testing device and was functional at the time of the inspection. This is not an exhaustive test, and does not predict the performance of the microwave.



16.0 Item 1(Picture)

- (2) The built in microwave was installed too close to the cooktop burners. This condition could cause damage to the plastic covering and the electronic control panel due to excessive heat. We recommend replacing the microwave with a low-profile microwave or relocating it which would allow at least 18 inches of clearance between the bottom of the microwave and the cooktop burners. Lower clearances may be allowed per manufacturers listing.

16.1 DISHWASHER

Comments:

IN NI NP RR IO Items

IN= Inspected, NI= Not Inspected, NP= Not Present, RR= Repair or Replace, IO= Information Only

Infrared Thermal photo of the dishwasher being tested.

The dishwasher was tested and functioned properly at the time of the inspection. This is not an exhaustive test and does not verify the cleaning efficiency of the dishwasher.



16.1 Item 1(Picture)

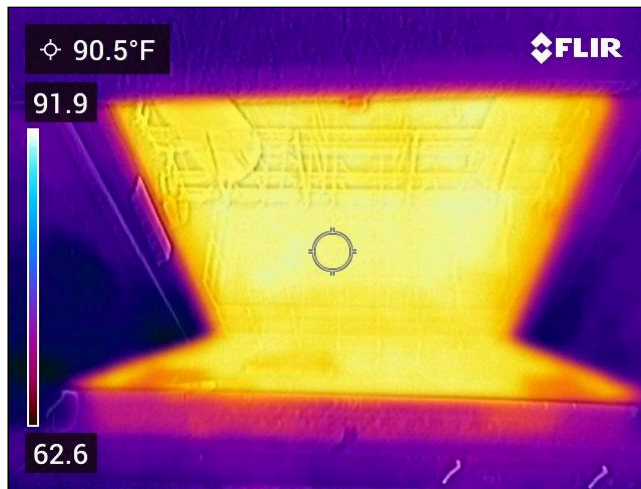

16.1 Item 2(Picture)

IN NI NP RR IO Items

16.2 FOOD WASTE DISPOSER

Comments:

The food waste disposer was tested and functioned properly at the time of the inspection. This is not an exhaustive test and does not verify the efficiency of the unit.

16.3 RANGE HOOD/ VENT

RANGE HOOD/ EXHAUST TYPE: VENTED

Comments:

The range exhaust vent was tested and was functional at the time of the the inspection. This is not an exhaustive test, and does not evaluate the performance or effectiveness of the unit.

16.4 RANGE/ OVEN

RANGE/ OVEN: GAS

Comments:

Infrared Thermal photo of the oven being tested.

The oven was tested and was functional at the time of the inspection. This test is not exhaustive and does not confirm the performance, accuracy, or effectiveness of the oven.



16.4 Item 1(Picture)

16.5 REFRIGERATOR

Comments:

(1) Refrigerators built in or not are not part of our general home inspection and are not inspected or commented on. If concerned about its serviceability and functionality we recommend further evaluation by a qualified licensed appliance contractor prior to the end of your contingency period.

(2) I could not identify or inspect the outlet or water shut off valve for the refrigerator. I do not move refrigerators in order to access the outlet or water shut off valve. Moving refrigerators is out of the scope of a home inspection are not moved to inspect the walls/floors/other components behind them. If concerned we recommend verifying that the outlet and water shut off valve is operational, not corroded and not leaking prior to the end of your contingency period.

IN NI NP RR IO Items

IN= Inspected, NI= Not Inspected, NP= Not Present, RR= Repair or Replace, IO= Information Only

The built-in appliances of the home were inspected and reported on with the above information. While the inspector makes every effort to find all areas of concern, some areas can go unnoticed. Please be aware that the inspector has your best interest in mind. Any repair items mentioned in this report should be considered before purchase. It is recommended that qualified licensed contractors be used in your further inspection or repair issues as it relates to the comments in this inspection report.

17. Gas, Electric, Water Shut-Off Locations

Home inspectors do not operate (turn) the main water supply shut off valve or the main gas shut off valve in accordance with industry standards of practice. If you are concerned about the functionality of these valves we recommend contacting a licensed plumber prior to the end of your contingency period for review. If you have questions about these exclusions, please contact your home inspector.

IN= Inspected, NI= Not Inspected, NP= Not Present, RR= Repair or Replace, IO= Information Only

IN NI NP RR IO Items

17.0 MAIN GAS SHUT-OFF VALVE

17.1 MAIN ELECTRICAL PANEL

Comments:

The Main Electrical panel is located at the left exterior side of the property (facing front).



17.1 Item 1(Picture)

17.2 MAIN WATER SHUT-OFF

Comments:

IN NI NP RR IO Items

IN= Inspected, NI= Not Inspected, NP= Not Present, RR= Repair or Replace, IO= Information Only

IN NI NP RR IO Items

The main water shut-off valve is located at the front exterior side of the property (facing front).

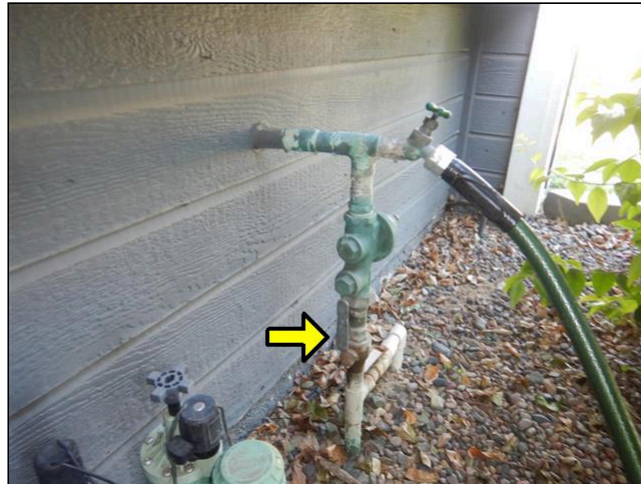

17.2 Item 1(Picture)

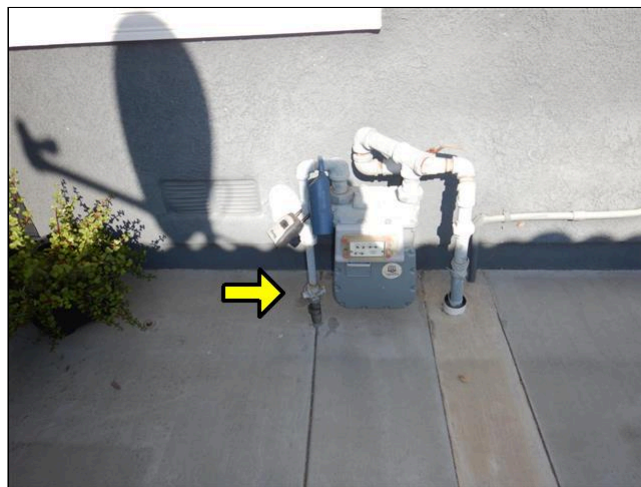

17.2 Item 2(Picture)

IN NI NP RR IO Items

IN= Inspected, NI= Not Inspected, NP= Not Present, RR= Repair or Replace, IO= Information Only

18. POOL, SPA, EQUIPMENT & SAFETY

Pools are fun, but children and adults can lose their life quickly. Over 4000 lives annually are lost with one-third under the age of 14. **A child can drown in the time it takes to answer a phone.** A swimming pool is 14 times more likely than a motor vehicle to be involved in the death of a child age 4 and under. An estimated 5,000 children ages 14 and under are hospitalized due to near-drownings each year; 15 percent die in the hospital and as many as 20 percent suffer severe, permanent brain damage. Of all preschoolers who drown, 70 percent are in the care of one or both parents at the time of the drowning and 75 percent are missing from sight for five minutes or less. Drowning surpasses all other causes of death to children age 14 and under in Arizona, California, Florida, Hawaii, Montana, Nevada, Oregon, Utah and Washington.

A pool alarm with a loud speaker system to sound outside as well as inside the home could save a life. Even if you do not have children you should be concerned. 35% of children that drowned did so in someone else's pool. For more info, do an Internet search on pool safety or visit this website: http://www.ihf.org/foryourhealth/article_children.html

IN= Inspected, NI= Not Inspected, NP= Not Present, RR= Repair/ Replace, IO= Information Only

IN NI NP RR IO Items

18.0 OPERATIONAL CONDITION OF POOL

Comments:

(1) Photo of the pool/ spa.



18.0 Item 1(Picture)

IN NI NP RR IO Items

IN= Inspected, NI= Not Inspected, NP= Not Present, RR= Repair/ Replace, IO= Information Only



18.0 Item 2(Picture)

(2) There is no visible rescue/ safety equipment placed around the pool/ spa area. This is a safety concern. We recommend placing the required rescue/ safety equipment where needed around the pool as a safety upgrade.

(3) Our company does not inspect pools for leaks or seepage. Only components readily accessible are inspected. If concerned we recommend further evaluation by a qualified licensed pool contractor.

18.1 OPERATIONAL CONDITION OF SPA

Comments:

The spa jets functioned when tested.



18.1 Item 1(Picture)

18.2 FENCING/ COVER

Comments:

Door alarms should be installed on all house doors that lead to the pool area due to no barrier between the house and the pool. We recommend installing door alarms in accordance with your local building requirements by a qualified licensed contractor.

18.3 SURFACE WALLS AND FLOOR OF POOL AND OR SPA

IN NI NP RR IO Items

SHAPE: SQUARE

WALL MATERIALS: AGED/ WORN, CONCRETE/ PLASTER

Comments:

The plaster is stained in several areas. This can be caused by poor chemical maintenance, foreign items that have stained the plaster, or rust from structural steel in the pool wall. We recommend further evaluation by a qualified licensed pool contractor to get an estimate of life remaining, and/or the cost of repair prior to the end of your contingency period.

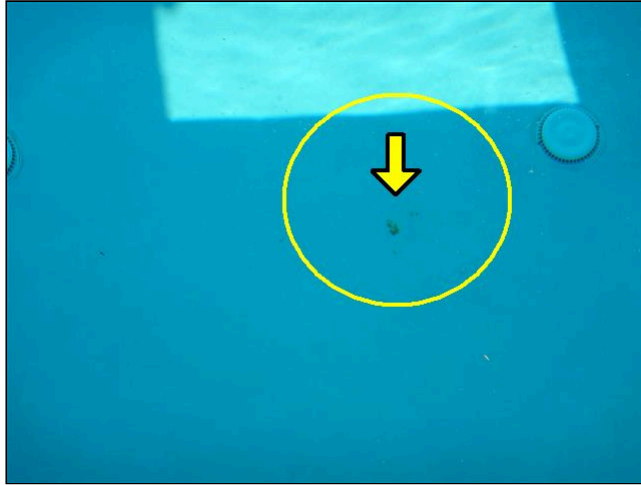

18.3 Item 1(Picture)

18.4 PERMANENT ACCESSORIES (steps, rails, diving board, ladder)

18.5 PLUMBING AND PUMPS

Comments:

The pool/spa pump(s) were tested and were found to be operational at the time of the inspection. Pumps are not evaluated for capacity, efficiency, flow rate or pressure.

18.6 HEATER

Comments:

IN NI NP RR IO Items

IN= Inspected, NI= Not Inspected, NP= Not Present, RR= Repair/ Replace, IO= Information Only

Infrared Thermal photo of the pool/ spa furnace being tested.



18.6 Item 1(Picture)

18.7 ELECTRICAL COMPONENTS

18.8 VALVES

18.9 SKIMMER

Comments:

The weir door in the skimmer is missing and should be replaced to prevent objects from entering into the skimmer. We recommend replacing the weir door by a qualified licensed pool contractor.

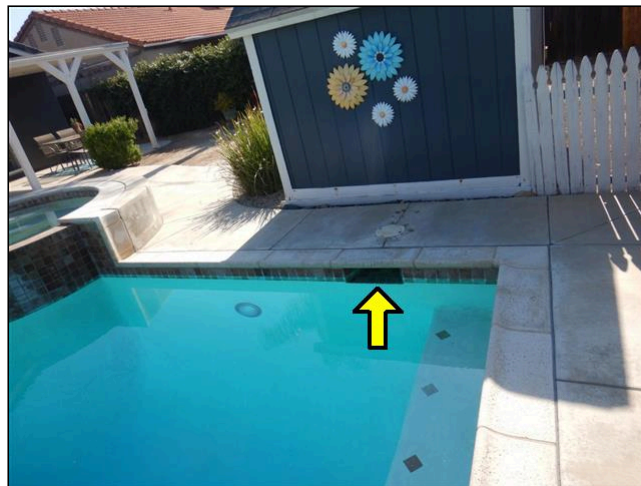

18.9 Item 1(Picture)

18.10 GFCI PROTECTION

Comments:

The GFCI outlet for the pool light(s) did not trip when tested. This is a safety concern. We recommend replacing the GFCI outlet by a qualified licensed electrician or pool contractor prior to using the pool/ as soon as possible.

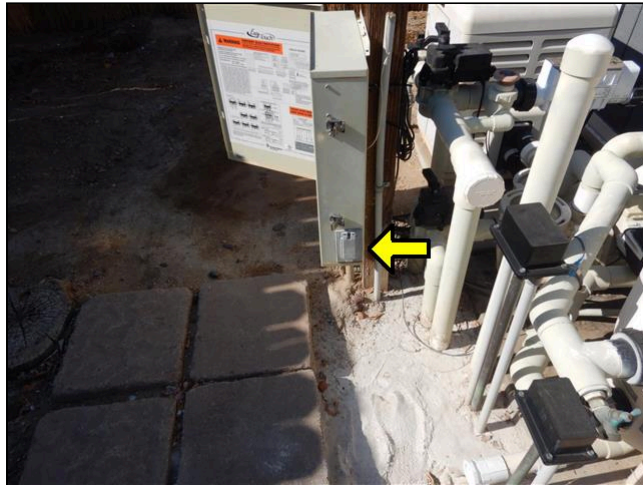

18.10 Item 1(Picture)



18.10 Item 2(Picture)

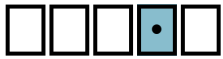

18.11 COPING/ DECK

Comments:

IN NI NP RR IO Items

The elastomeric compound (Deck-O-Seal) between the pool/ spa deck and coping is cracked/ missing in several areas. We recommend re sealing between the pool/ spa deck and coping as needed by a qualified pool contractor.



18.11 Item 1(Picture)

18.12 DRAIN COVERS

18.13 POOL/ SPA LIGHT

Comments:

(1) Photo of pool/ spa light(s) on.



18.13 Item 1(Picture)

IN NI NP RR IO Items

IN= Inspected, NI= Not Inspected, NP= Not Present, RR= Repair/ Replace, IO= Information Only



18.13 Item 2(Picture)

(2) Pool and spa light(s) are not taken out and we did not observe the condition of the wiring to the pool and spa light(s). This is out of the scope of a general home inspection. If concerned about the wiring to these lights we recommend further evaluation by a licensed pool contractor prior to the end of your contingency period.

(3) Pool and spa light(s) are not taken out and we did not observe the condition of the wiring to the pool and spa light(s). This is out of the scope of a general home inspection. If concerned about the wiring to these lights we recommend further evaluation by a licensed pool contractor prior to the end of your contingency period.



18.14 POOL/ SPA FILL

Comments:

The pool fill device was tested and was operational at the time of the inspection.



18.14 Item 1(Picture)

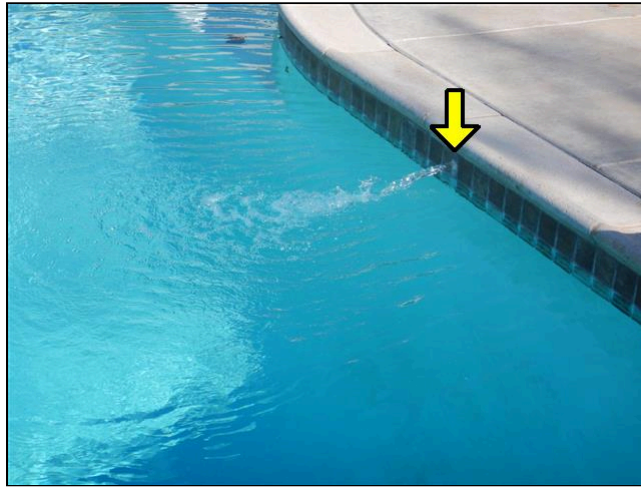

18.14 Item 2(Picture)

18.15 CHLORINATOR

18.16 POOL SWEEP

Comments:

The pool sweep functioned at the time of the inspection. This is not an exhaustive test and does not verify the cleaning efficiency of the unit.

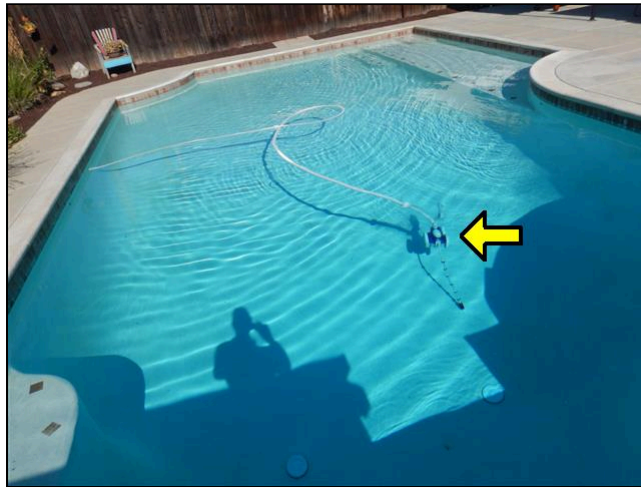

18.16 Item 1(Picture)

18.17 FILTER

Comments:

The filter appeared to be functional at the time of the inspection. This is not an exhaustive test and does not verify the cleaning efficiency of the unit.

18.18 SOLAR PANELS

Comments:

IN NI NP RR IO Items

The solar heating system on roof was observed to be leaking. We recommend recommend necessary repairs or replacement by a qualified licensed pool contractor.



18.18 Item 1(Picture)

IN NI NP RR IO Items

IN= Inspected, NI= Not Inspected, NP= Not Present, RR= Repair/ Replace, IO= Information Only

Unless so mentioned in this report, I did not test water for bacteria or quality. The pool was inspected and reported on with the above information. While the inspector makes every effort to find all areas of concern, some areas can go unnoticed. Please be aware that the inspector has your best interest in mind. Any repair items mentioned in this report should be considered before purchase. It is recommended that qualified licensed contractors be used in your further inspection or repair issues as it relates to the comments in this inspection report.

General Summary



The Property Inspection Pros

www.tpips.com
jduncan@tpips.com
Cell - 760-525-5340
Certified Master Inspector

Customer
Jimmy Smith

Address
1241 Main Ct
Menifee CA 92584

The following items or discoveries indicate that these systems or components **do not function as intended** or **adversely affects the habitability of the dwelling**; or **warrants further investigation by a specialist**, or **requires subsequent observation**. This summary shall not contain recommendations for routine upkeep of a system or component to keep it in proper functioning condition or recommendations to upgrade or enhance the function or efficiency of the home. This Summary is not the entire report. The complete report may include additional information of concern to the customer. It is recommended that the customer read the complete report.

1. Roofing

1.2 FLASHINGS AND ROOF PENETRATIONS

Repair or Replace

Drip edge flashing was not installed at the roof. Lack of roof drip edge flashing leaves the edges/eaves of roof sheathing, fascia and underlayment exposed to potential moisture damage from wood decay and/or delamination. We recommend having drip edge flashing installed by a licensed roof contractor.

1.3 ROOF DRAINAGE (GUTTERS/ DOWNSPOUTS)

Not Present

Gutters, downspouts and drain lines are not installed. We recommend installing gutters and downspouts to prevent erosion or water intrusion around the house by diverting run off away from the house by a qualified licensed contractor.

2. Exterior

2.3 WALL CLADDING FLASHING AND TRIM

Inspected

Several gaps were observed at the siding. These gaps can allow water to flow behind the siding causing damage. We recommend caulking the gaps as needed to seal the siding and prevent water intrusion.

2.6 WINDOWS (INTERIOR AND EXTERIOR)**Repair or Replace**

(1) There are several window screens that are damaged throughout the house. We recommend repair or replace as needed by a qualified person.

2.8 DRIVEWAYS, PATIOS, WALKWAYS (HARDSCAPE)**Repair or Replace**

(1) There is a crack in the concrete driveway. We recommend necessary repairs by a licensed concrete contractor.

(2) There are several cracks in the concrete patio. We recommend necessary repairs by a licensed concrete contractor.

2.10 FENCE AND/OR GATES**Repair or Replace**

(1) The fence and gates are loose, leaning and deteriorated in several areas. We recommend necessary repairs or replacing as needed by a licensed fence contractor.

(2) The left side gate is damaged. We recommend necessary repairs or replacing as needed by a licensed fence contractor.

(3) There is a lock installed on the right side gate. This gate could not be inspected for proper operation due to this condition. We recommend having the lock removed and verifying that the gate is operational by a qualified person prior to the end of your contingency period.

(4) Vegetation is growing on the fence in several areas. Vegetation can hold moisture to the fence and cause excessive weight and damage. We recommend trimming back and removing the vegetation by a qualified licensed landscaper.

3. Electrical System

3.2 CIRCUIT BREAKERS/ FUSES**Inspected**

(2) Breakers were observed in the main panel which are from a manufacturer that is different than the panel manufacture. Most panel manufacturers require like-kind breakers to be installed from the same manufacture. Having breakers from another manufacturer could void the UL listing. We recommend further evaluation by a qualified licensed electrician and necessary corrections as needed.

3.3 BRANCH CIRCUIT CONDUCTORS/ WIRING**Inspected**

(2) Wires for some lighting fixtures in the attic space were observed to be unsecured. We recommend necessary corrections by a qualified licensed electrician.

3.4 SERVICE AND GROUNDING EQUIPMENT**Inspected**

The electrical system appears to be grounded through the plumbing system only which was standard at the time of construction. Newer homes have a separate ground rod which improves grounding. We recommend having a ground rod and wire installed by a qualified licensed electrician to improve grounding and safety.

3.9 OPERATION OF GFCI (GROUND FAULT CIRCUIT INTERRUPTERS)**Inspected**

(2) We recommend upgrading all receptacles within 6 feet of any plumbing fixtures, outside/ exterior, in the garage, and any non fixed appliance receptacles in the kitchen to GFCI protected receptacles by a qualified licensed electrician for safety.

3.10 JUNCTION BOXES (OBSERVABLE)

Repair or Replace

(1) An open junction box is observed at the pool equipment. All electrical splices must be enclosed in a junction box. We recommend necessary repairs by a qualified person for safety.

(2) Open wire splices were observed in the garage. This is non standard. All wire splices connections must be enclosed in a covered junction box. We recommend enclosing the open wire splices in an approved junction box by a qualified licensed electrician.

3.11 EXTERIOR LIGHTING**Repair or Replace**

(1) The exterior light fixtures were not sealed where the fixture meets the wall. This condition could allow moisture intrusion in this area. We recommend sealing exterior light fixtures where they meet the wall by a qualified person.

4. Garage

4.1 GARAGE VEHICLE DOOR OPENER(S)**Inspected**

(1) Due to the high number of garage door openers that fail to auto-reverse when testing the garage door openers pressure-activated auto-reverse feature which could cause severe damage to the garage door and its related components when it fails to auto-reverse, we did not test the garage door openers pressure-activated auto-reverse feature at the time of the inspection. We recommend having the garage door(s) pressure-activated auto-reverse feature tested prior to the end of your contingency period by a qualified licensed garage door contractor.

4.3 GARAGE WALLS (INCLUDING FIREWALL SEPERATION)**Repair or Replace**

(1) Due to occupants personal items, not all areas of the property were visible and accessible at the time of the inspection. Several windows, doors, outlets, walls, flooring, and other areas were obstructed from view and could not be inspected. The home inspector does not move personal items, panels, furniture, equipment, plant life, soil, debris, ect. that obstructs their access or visibility. We recommend that you conduct a careful evaluation during your final walk-through or prior to the end of your contingency period to ensure that there are no hidden defects. All doors, windows, and outlets should be tested and verified for proper operation prior to the end of your contingency period by a qualified person. If any damage is observed we recommend asking the seller about it. We recommend that any damage found be repaired or replaced by a qualified licensed contractor in the appropriate trade.

(2) There are several holes observed in the fire wall in the garage. Wherever the garage shares a wall with adjacent living space, the fire-rated sheetrock must be installed and intact for fire resistive performance. We recommend having the holes patched with fire-rated drywall or necessary corrections by a qualified licensed contractor.

(3) Hairline cracking was observed at the garage walls in several areas. These hairline cracks are likely due to material shrinkage or settlement of the structure. We recommend prep and paint by a qualified licensed painter.

4.5 FIRE-RATED DOOR**Inspected**

The door between the house and garage did not have a Fire Rating Certificate or Plate. Without a plate, I could not confirm whether the door meets fire code safety requirements. We recommend further evaluation by a licensed door contractor. The "fire door" is required to meet one of the following characteristics: 1-3/8 inch thick solid wood, 1-3/8 inch thick steel shell door with Honeycomb core, Fire-rated (with certificate plate). If the door is not rated as a fire door we recommend replacing by a qualified licensed door contractor for safety.

4.6 FIRE-DOOR CLOSING DEVICE**Inspected**

(2) The door to the garage has a door stopper installed at the bottom of the door. The door stopper defeats the auto closer, which is required. We recommend removal of the door stopper to maintain the integrity of the fire wall and fire door.

4.8 GARAGE PEDESTRIAN DOOR(S)**Repair or Replace**

Weather-stripping was not installed at garage pedestrain door. We recommend installing weather-stripping by a qualified person.

4.9 OUTLETS/ FIXTURES/ WIRING/ 220V**Repair or Replace**

(1) There is exposed Romex type wires noted in the garage in several areas. This is a safety concern if used where it could be subject to physical damage. Romex wires are normally used in attics, inside walls, or inside conduit. We recommend necessary corrections by a qualified licensed electrician for safety.

(2) Wire clamps are missing at a junction box located in the garage. This is non standard. A plastic bushing or wire clamp protects and secures the wiring as it enters into the junction box. We recommend installing plastic bushings or wire clamps by a qualified licensed electrician.

5. Water Heater

5.0 MAIN WATER HEATER (CONTROLS)**Inspected**

(4) A leak pan is not installed under the water heater. We recommend installing a leak pan under the water heater by a qualified licensed plumber.

6. Interiors

6.0 INTERIORS (GENERAL COMMENTS)**Inspected**

(4) We did not test the property for asbestos. Testing for asbestos is out of the scope of a general home inspection and was not done by this company at the time of the inspection. If your concerned that the this property may contain asbestos, we recommend that you have the property tested for asbestos prior to the end of your contingency period by a qualified licensed contractor.

6.5 COUNTERS AND CABINETS (REPRESENTATIVE NUMBER)**Repair or Replace**

(2) The bottom shelf in the cabinet below the kitchen sink is bowed/ damaged. We recommend necessary repairs or replacement by a qualified licensed qualified contractor.

6.6 DOORS (REPRESENTATIVE NUMBER)**Repair or Replace**

Several doors are missing. We recommend replacing where needed by a qualified person.

6.9 INTERIORS - OTHER**Inspected**

(2) MAINTENANCE RECOMMENDATION: We recommend re sealing (caulking or grouting) around all sink to counter top junctions and backsplash to countertop junctions, and around all bathroom shower pan(s), curb(s), tub/ shower floor junctions, and adjacent walls throughout the house or where needed by a qualified person to help prevent moisture intrusion in these areas.

6.10 ADDITIONS/ MODIFICATIONS**Information Only**

The garage appears to have undergone major renovations, remodeling, and additions to the original structure. It is beyond the scope of our general home inspection to verify the existence of permits. We recommend checking city records to verify the existence of permits prior to the end of your contingency period.

7. Plumbing System

7.2 WATER PRESSURE/ REGULATOR

Inspected

The water pressure was checked with a water pressure gauge and was measured to be higher than 80 PSI at the time of the inspection. This is too high and corrections are needed. We recommend further evaluation by a qualified licensed plumber for necessary repairs or corrections.

7.3 HOSE SPIGOT(S)

Inspected

(2) The exterior hose spigots do not have anti-siphon or anti-backflow devices installed on them. These anti-siphon or anti-backflow devices help prevent contaminated water from flowing back into the house water supply system. We recommend installing anti-siphon or anti-backflow devices at every exterior hose spigots by a qualified person.

8(A) . Bathroom(s) / Hall Bathroom

8.0.A TUB/ SHOWER ENCLOSURE

Repair or Replace

The tub/ shower faucet valve does not back stop. This condition allows the tub faucet valve to turn past the off position without stopping. We recommend necessary repairs or replacement by a qualified licensed plumber.

8(B) . Bathroom(s) / Master Bathroom

8.1.B SHOWER

Repair or Replace

Non-standard height was observed at the shower curb/ threshold. Normally a shower curb/ threshold is a minimum 2" above the drain. (usually a 4" threshold, with a maximum allowable of 9"). We recommend further evaluation by a qualified licensed contractor and repairs made as needed.

9. Laundry

9.1 CLOTHES DRYER VENT

Repair or Replace

(1) The dryer is equipped with a foil, accordion-type duct. The U.S. Consumer Product Safety Commission considers these types of ducts to be unsafe and a fire hazard. The flexible foil type duct can more easily trap lint and is more susceptible to kinks or crushing, which can greatly reduce the airflow. We recommend replacing the duct with a rigid or corrugated semi-rigid metal duct.

(2) We recommend having the dryer vent cleaned by a qualified person.

(3) We recommend having the dryer vent cleaned by a qualified person.

10. Fireplaces/ Chimneys

10.0 CHIMNEY(S)

Inspected

(1) We recommend having the fireplace and chimney cleaned and inspected by a licensed chimney sweep for safety prior to using.

10.1 FIREPLACE(S)

Inspected

The spark screen at the fireplace is missing. We recommend replacement.

11. Detectors, Safety, Security

11.1 CARBON MONOXIDE DETECTOR(S)

Repair or Replace

(2) The quantity of Carbon Monoxide detectors that are required to be installed varies with each house. Larger houses, or those with multiple levels are required to have more CO detectors. A Carbon Monoxide detector is required on each level of a multi-level house and adjacent to each cluster of bedrooms. We recommend installing additional Carbon Monoxide detectors where needed.

12. Heating Equipment

12.0 HEATING EQUIPMENT

Inspected

(3) The gas supply pipe at the furnace did not contained a drip leg/ sediment trap. This may have been standard at the time of installation but now is highly recommended. The purpose of a drip leg is to help prevent sediment/ debris from entering and clogging the furnace gas valve which could cause the furnace to shut down. We recommend having a drip leg installed by a qualified licensed HVAC contractor.

(6) The furnace is not sealed around the base of the unit. We recommend having the base of the furnace be sealed by a qualified person.

13. Cooling Equipment

13.0 COOLING EQUIPMENT

Inspected

(4) The AC unit electrical conduit is not secured to the wall as required. We recommend having the AC unit conduit secured to the wall by a qualified person.

(5) The AC unit electrical conduit is in contact with the ground. This is non-standard. We recommend necessary corrections by a qualified person.

13.1 CONDENSATE EQUIPMENT

Inspected

(1) There is no secondary AC condensation drain installed. This may have been acceptable at time of installation. However, today a secondary drain or alternate device is required to prevent damage in case of a clog in the primary drain. We recommend installing a secondary drain or alternate device by a qualified licensed HVAC contractor.

(2) A vented trap was not installed in the condensation drain line. A vented trap must be installed in the condensation drain line to prevent vapor lock and possible condensation leaks in the house. We recommend installation of a vented trap by a qualified licensed HVAC contractor.

14. Ventilation and Insulation

14.0 INSULATION IN THE ATTIC SPACE

Repair or Replace

(3) The attic space access hatch cover is not insulated. We recommend insulating the attic access hatch cover to reduce unwanted heat loss/gain by a qualified person.

16. Built-In Kitchen Appliances

16.0 MICROWAVE (BUILT-IN)

Repair or Replace

(2) The built in microwave was installed too close to the cooktop burners. This condition could cause damage to the plastic covering and the electronic control panel due to excessive heat. We recommend replacing the microwave with a low-profile microwave or relocating it which would allow at least 18 inches of clearance between the bottom of the microwave and the cooktop burners. Lower clearances may be allowed per manufacturers listing.

18. POOL, SPA, EQUIPMENT & SAFETY

18.0 OPERATIONAL CONDITION OF POOL

Inspected

(2) There is no visible rescue/ safety equipment placed around the pool/ spa area. This is a safety concern. We recommend placing the required rescue/ safety equipment where needed around the pool as a safety upgrade.

18.2 FENCING/ COVER

Inspected

Door alarms should be installed on all house doors that lead to the pool area due to no barrier between the house and the pool. We recommend installing door alarms in accordance with your local building requirements by a qualified licensed contractor.

18.3 SURFACE WALLS AND FLOOR OF POOL AND OR SPA

Inspected

The plaster is stained in several areas. This can be caused by poor chemical maintenance, foreign items that have stained the plaster, or rust from structural steel in the pool wall. We recommend further evaluation by a qualified licensed pool contractor to get an estimate of life remaining, and/or the cost of repair prior to the end of your contingency period.

18.5 PLUMBING AND PUMPS

Inspected

The pool/spa pump(s) were tested and were found to be operational at the time of the inspection. Pumps are not evaluated for capacity, efficiency, flow rate or pressure.

18.9 SKIMMER

Repair/ Replace

The weir door in the skimmer is missing and should be replaced to prevent objects from entering into the skimmer. We recommend replacing the weir door by a qualified licensed pool contractor.

18.10 GFCI PROTECTION

Repair/ Replace

The GFCI outlet for the pool light(s) did not trip when tested. This is a safety concern. We recommend replacing the GFCI outlet by a qualified licensed electrician or pool contractor prior to using the pool/ as soon as possible.

18.11 COPING/ DECK

Repair/ Replace

The elastomeric compound (Deck-O-Seal) between the pool/ spa deck and coping is cracked/ missing in several areas. We recommend re sealing between the pool/ spa deck and coping as needed by a qualified pool contractor.

18.18 SOLAR PANELS

Repair/ Replace

The solar heating system on roof was observed to be leaking. We recommend necessary repairs or replacement by a qualified licensed pool contractor.

Home inspectors are not required to report on the following: Life expectancy of any component or system; The causes of the need for a repair; The methods, materials, and costs of corrections; The suitability of the property for any specialized use; Compliance or non-compliance with codes, ordinances, statutes, regulatory requirements or restrictions; The market value of the property or its marketability; The advisability or inadvisability of purchase of the property; Any component or system that was not observed; The presence or absence of pests such as wood damaging organisms, rodents, or insects; or Cosmetic items, underground items, or items not permanently installed. Home inspectors are not required to: Offer warranties or guarantees of any kind; Calculate the strength, adequacy, or efficiency of any system or component; Enter any area or perform any procedure that may damage the property or its components or be dangerous to the home inspector or other persons; Operate any system or component that is shut down or otherwise inoperable; Operate any system or component that does not respond to normal operating controls; Disturb insulation, move personal items, panels, furniture, equipment, plant life, soil, snow, ice, or debris that obstructs access or visibility; Determine the presence or absence of any suspected adverse environmental condition or hazardous substance, including but not limited to mold, toxins, carcinogens, noise, contaminants in the building or in soil, water, and air; Determine the effectiveness of any system installed to control or remove suspected hazardous substances; Predict future condition, including but not limited to failure of components; Since this report is provided for the specific benefit of the customer(s), secondary readers of this information should hire a licensed inspector to perform an inspection to meet their specific needs and to obtain current information concerning this property.

Prepared Using HomeGauge <http://www.HomeGauge.com> : Licensed To Jeff Duncan